



---

**Design Your Own Chips  
on our WEB site**

---

With our interactive and easy to use chip design tool, you can now choose your own moulds and colours to create chips that will be unique to your casino.

[www.matsui-gaming.co.jp](http://www.matsui-gaming.co.jp)



CASINO EQUIPMENT

---

**Matsui Gaming Machine co.,LTD.**

( TOKYO, JAPAN )  
TEL : 81-3-5467-5211 FAX : 81-3-5467-5218

**M·G·M WORLD co.,LTD.**

( SHIHWA, KOREA )  
TEL : 82-31-431-8611 FAX : 82-31-431-8638

**MATSUI ASIA LTD.**

( MACAU S.A.R, CHINA )  
TEL : 853-2875-2830 FAX : 853-2875-2831

**MATSUI AMERICA INC.**

( LAS VEGAS, U.S.A )  
TEL : 1-702-220-4911 FAX : 1-702-589-5858

**MATSUI EUROPE LTD.**

( WARRINGTON, U.K. )  
TEL : 44-(0)161-736-9011 FAX : 44-(0)161-736-9002

# CHIP COLOUR CHART

These printed colours are a close representation only and may vary slightly on the finished chip. Please contact your MATSUI sales representative for design and chip colour kit.



## Standard Chip Colour

01 Light Blue	02 Aquamarine	03 True Blue	04 Cobalt Blue	05 Ultramarine	06 Dark Blue	07 Indigo Blue	08 Purple
09 Violet	10 Hot Pink	11 Lavender	12 Blush	13 Rose	14 Day-Glo Pink	15 Crimson	16 Maroon
17 Scarlet	18 Vermilion	19 Orange	20 Day-Glo Orange	21 Mandarin Orange	22 Flesh	23 Dandelion Yellow	24 Lemon
25 Mustard	26 Light Green	27 Mint	28 Irish Green	29 Lawn Green	30 Leaf Green	31 Cedar Green	32 Terracotta
33 Dark Brown	34 Sienna Brown	35 Fawn	36 Beige	37 Cream	38 White	39 Light Grey	40 Battleship Grey
41 Stone Grey	42 Black	43 Dark Green					

## Marble Chip Colour

AN04 Sapphire	AN11 Coral	AN13 Magenta	AN14 Canary	AN15 Carmine	AN17 Pearl Gold	AN18 Sand	AN19 Bronze
AN24 Gold	AN25 Pearl Grey	AN29 Syan	AN31 Forest Green	AN32 Antique Black	AN33 Silver	AN41 Emerald	

# GAMING CHIPS

Utilizing the most recent and accurate technology available, MATSUI has now extended their existing range of highly durable gaming chips. In addition to their hard wearing properties, all Matsui gaming chips feel great to the touch and are perfectly weighted for any casino player.



INNER RING STYLE  
DECAL VALUE CHIPS



EDGE INSERT STYLE  
DECAL VALUE CHIPS



HEAVY WEIGHT  
INNER RING STYLE  
DECAL VALUE CHIPS



DECAL VALUE  
CHIPS



ROULETTE WHEELCHECKS



COIN INLAY  
VALUE CHIPS



GOLD / SILVER  
CHIPS



PAD PRINT /  
HOT STAMP  
CHIPS



PREMIER DECAL CHIPS



PREMIER DECAL CHIPS



ACRYLIC PLAQUES

## CHIP COLOUR COMBINATION



### SECURITY OPTION

- Visible UV
- Invisible UV
- Mould UV
- MG EYE Security Printing
- MG EYE Edge
- Laser Trace
- EM Tag
- RFID

### ADDITIONAL DESIGNS

- Glitter
- Mirror Silver
- Mirror Gold
- Serial Numbers
- Hologram

# INNER RING STYLE Decal Value Chips

Matsui Inner Ring Decal Chips are our most popular and best-selling casino chips. We have a wide selection with a full range of denominations. The inner rings moulds are available in number only, \$ and € and will fit 39mm, 40mm and 43mm chips. With this wide-ranging selection, we are sure to have the denominations you require and it is also possible to customize your own unique inner ring mould.



## 40 mm 2 colour

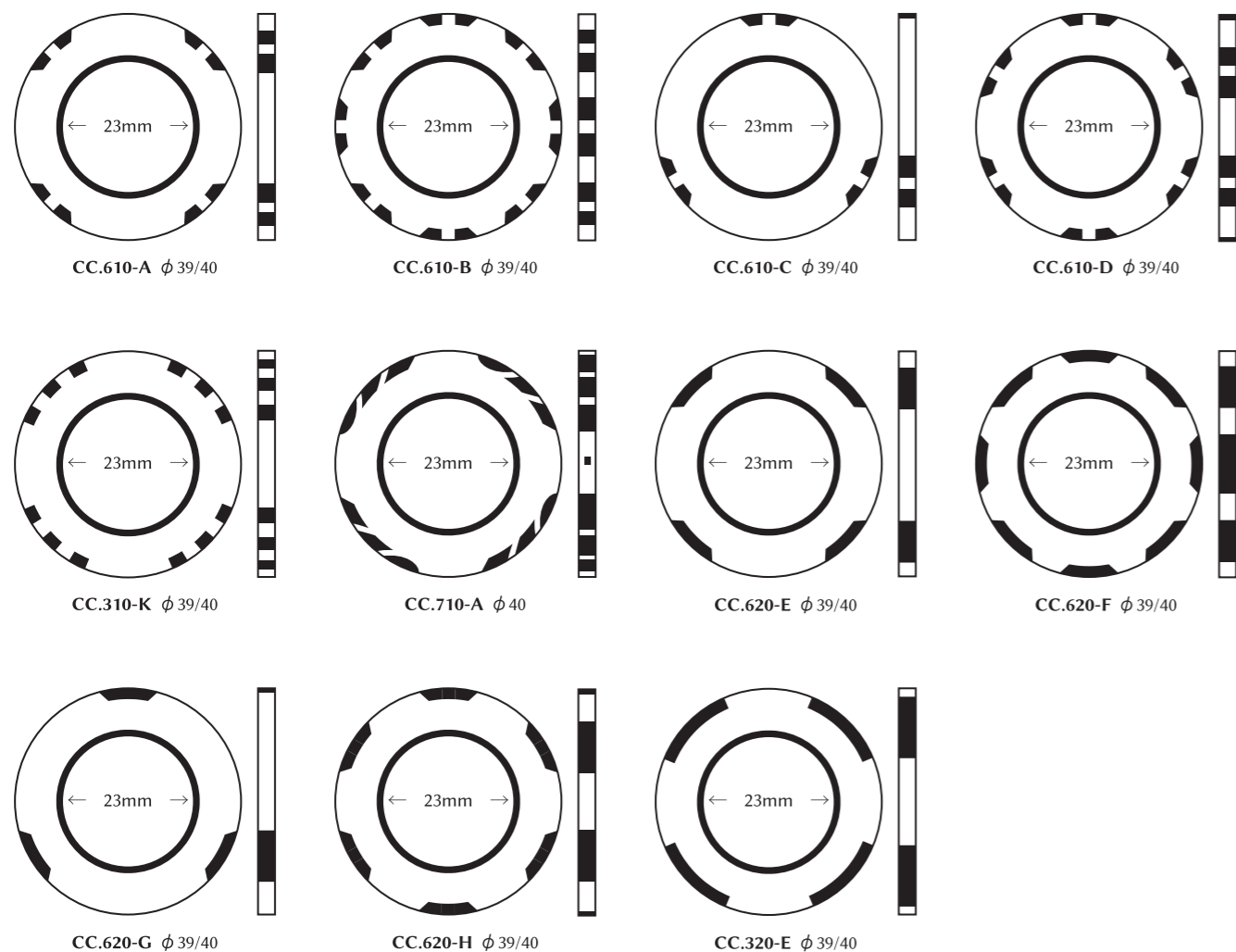

## 40 mm 3 colour

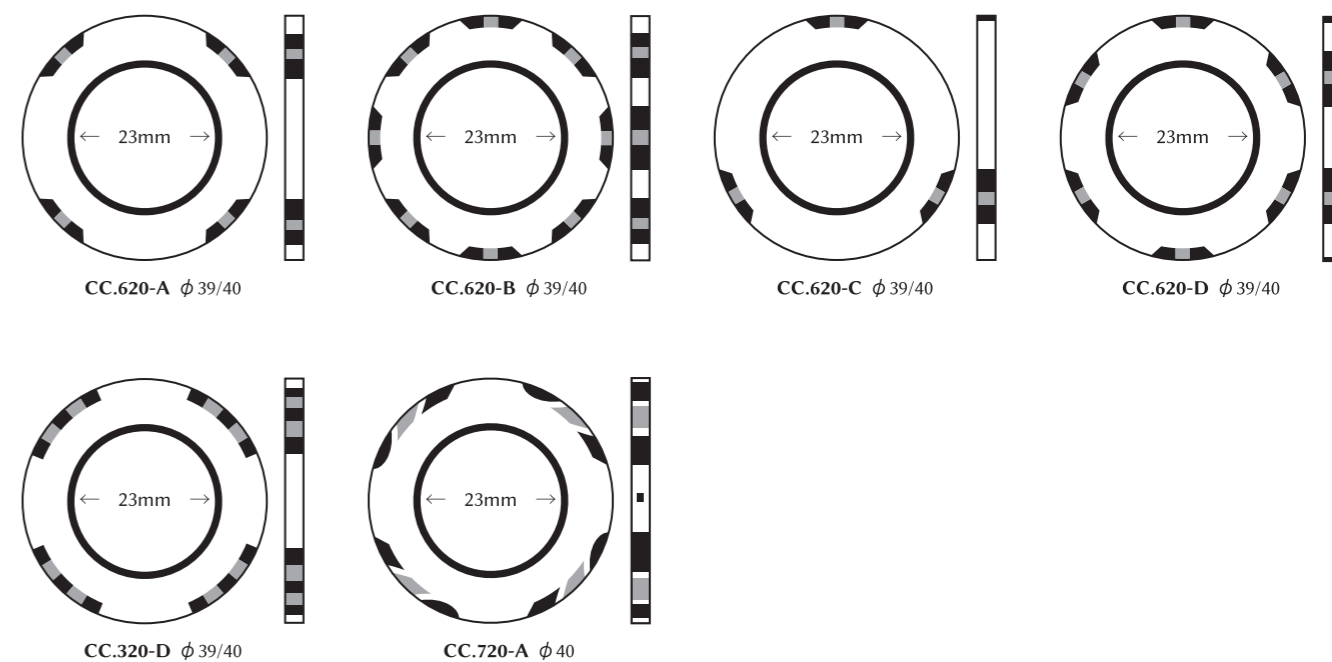

## 40 mm 4 colour

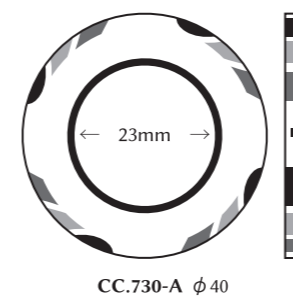

### CHIP COLOUR COMBINATION

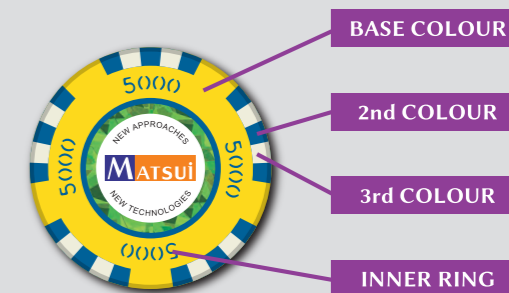

\*Inner Ring to be same colour as 2nd colour

### SECURITY OPTION

- Visible UV
- Invisible UV
- Mould UV
- MG EYE Security Printing
- MG EYE Edge
- Laser Trace
- EM Tag
- RFID

### ADDITIONAL DESIGNS

- Glitter
- Mirror Silver
- Mirror Gold
- Serial Numbers
- Hologram

43 mm 2 colour

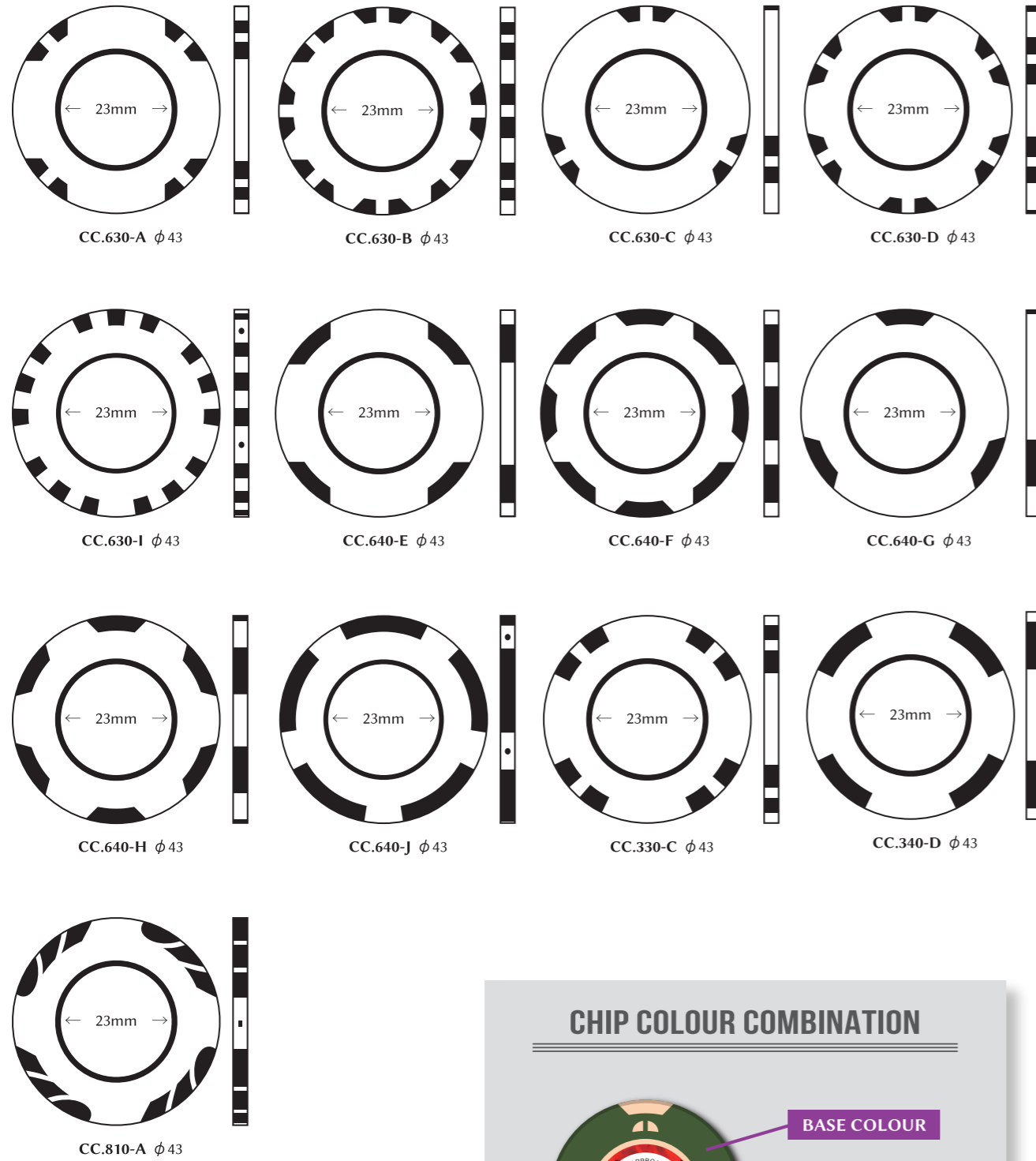

**CHIP COLOUR COMBINATION**

BASE COLOUR

2nd COLOUR

INNER RING

\*Inner Ring to be same colour as 2nd colour

43 mm 3 colour

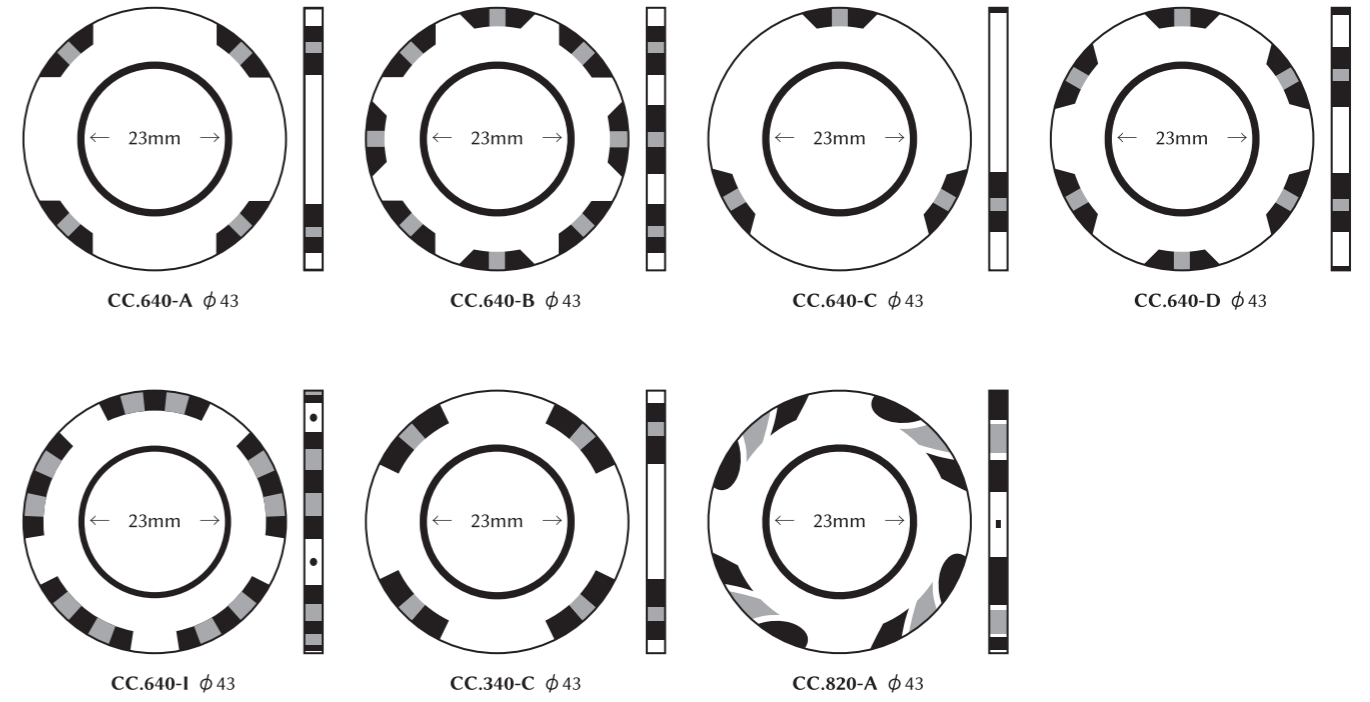

43 mm 4 colour

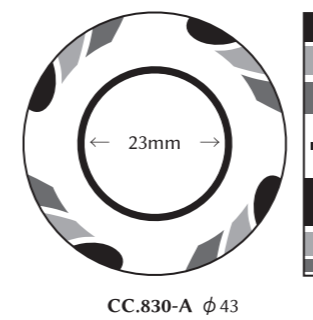

45 mm 2 colour

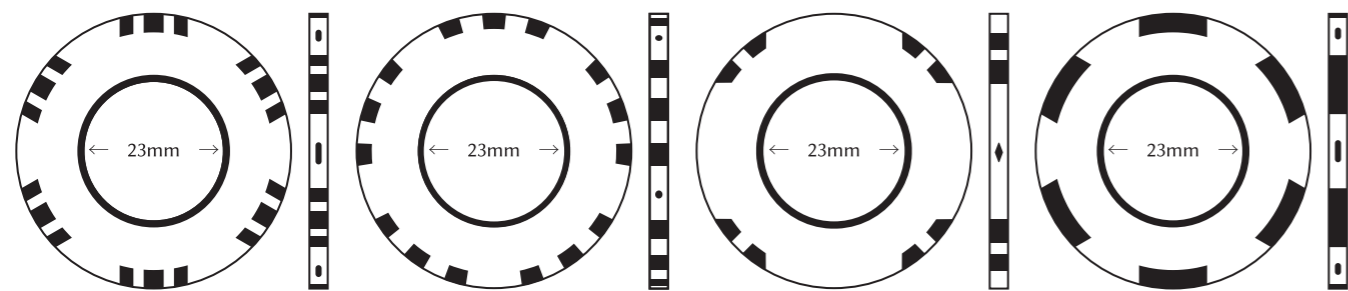

CC.635-A  $\phi$  45

CC.635-C  $\phi$  45

CC.635-E  $\phi$  45

CC.645-B  $\phi$  45

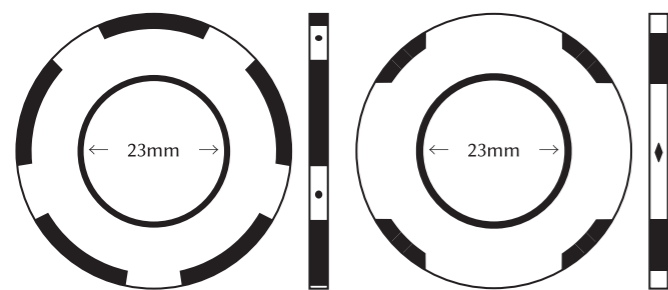

CC.645-D  $\phi$  45

CC.645-F  $\phi$  45

50 mm 2 colour

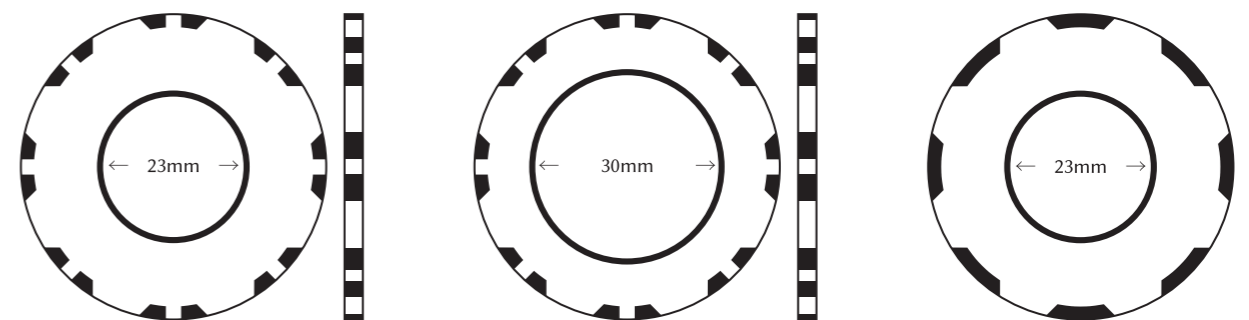

CC.650-A  $\phi$  50

CC.650-B  $\phi$  50

CC.660-C  $\phi$  50

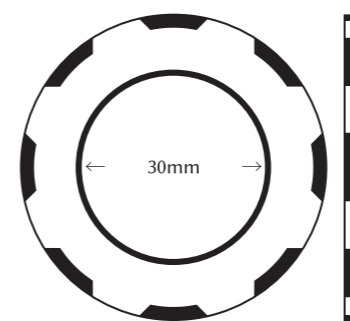

CC.660-D  $\phi$  50

45 mm 3 colour

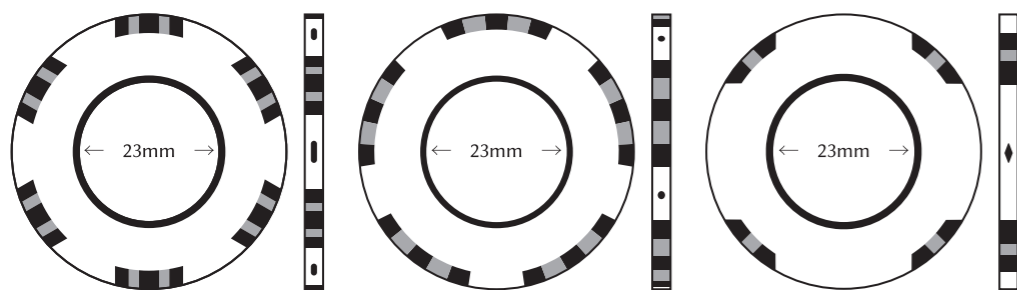

CC.645-A  $\phi$  45

CC.645-C  $\phi$  45

CC.645-E  $\phi$  45

50 mm 3 colour

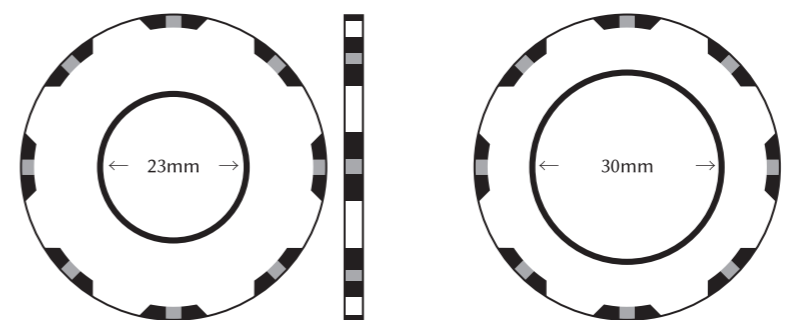

CC.660-A  $\phi$  50

CC.660-B  $\phi$  50

## One colour Inner Series

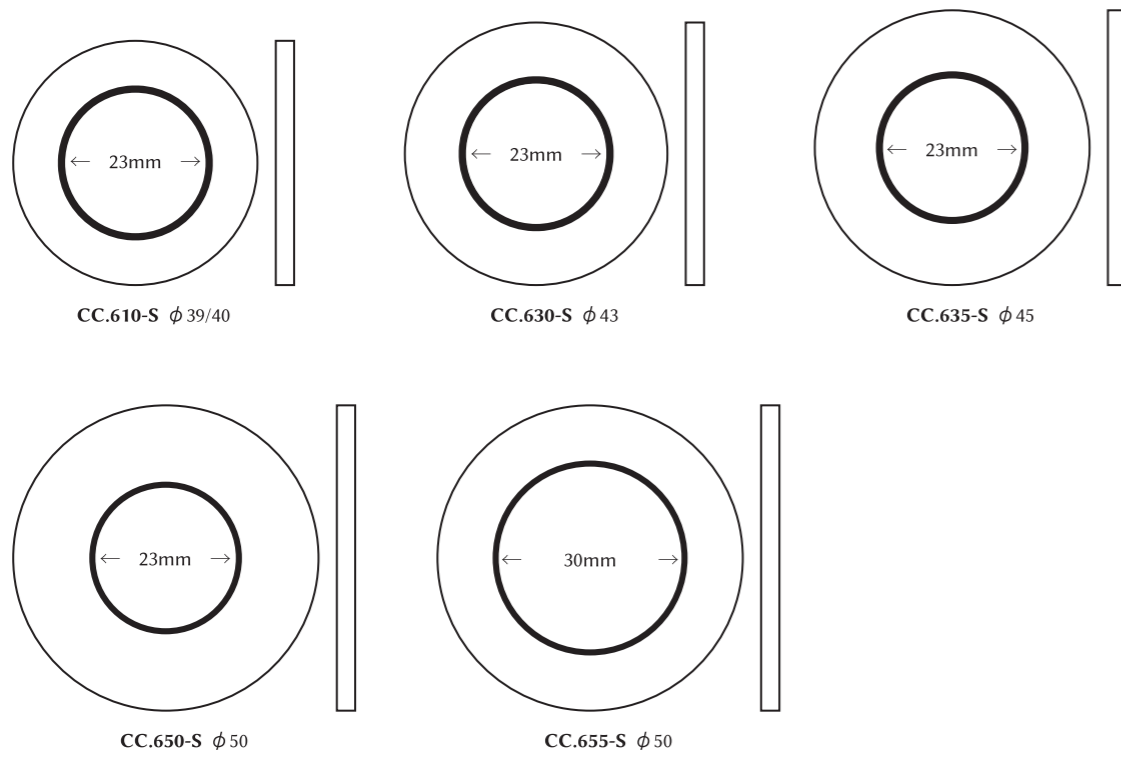

## INNER RING Designs

We have many inner ring designs and denominations available as standard. There is also the further option to have your own casino name in the inner ring of the chip for a more personalized appearance.



### Inner Ring Designs 40/43/45 mm Decal 23mm ONLY

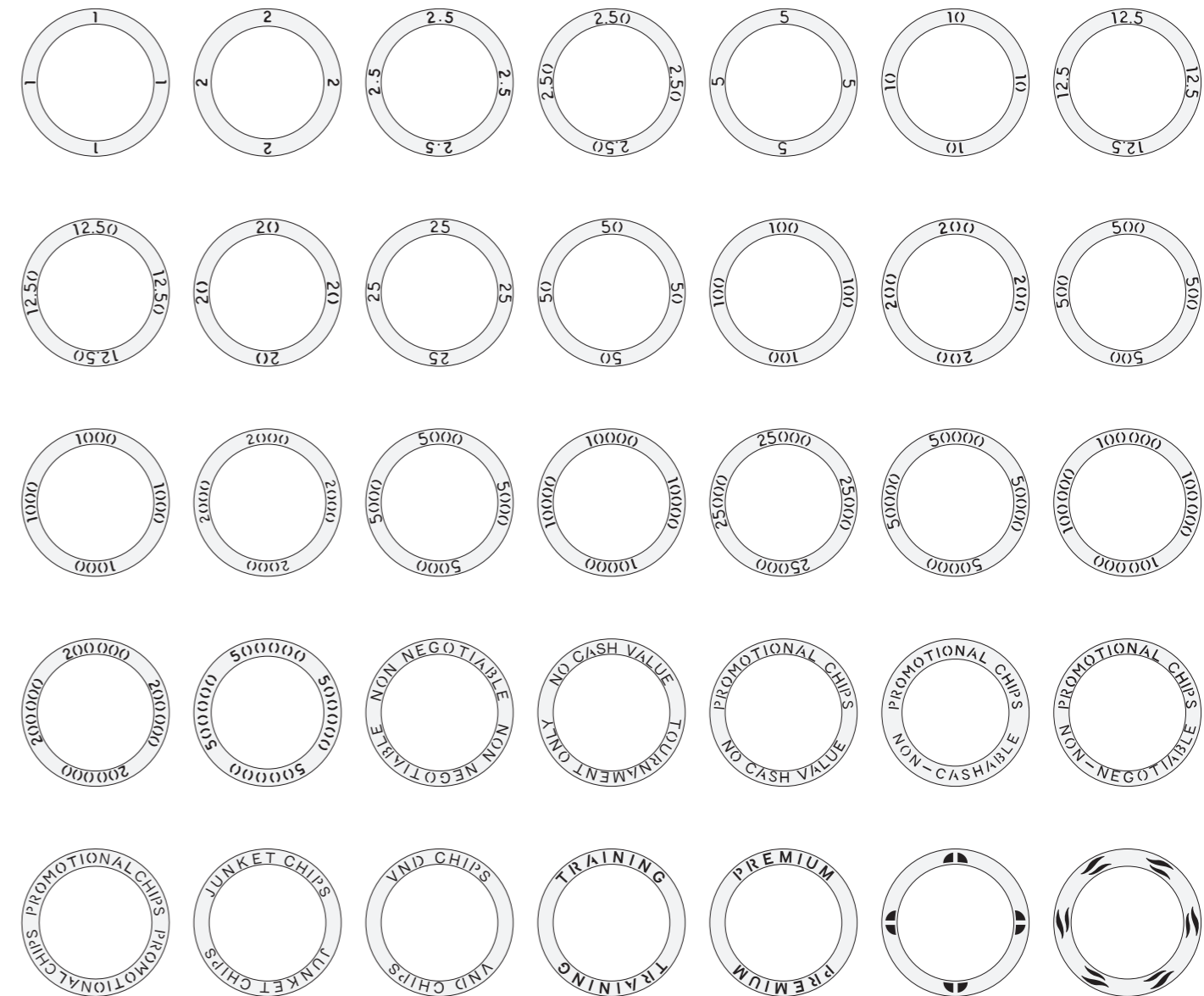

### INNER RING CAN BE CUSTOMIZED

Other inner ring designs are also available. Please contact your local sales representative for more information.

\*The ability to customize chips with your casino name is available.

\*The inner ring color is always the same as the second colour of your chip.



**EP Inner Ring Designs 40/43/45 mm** Decal 23mm ONLY

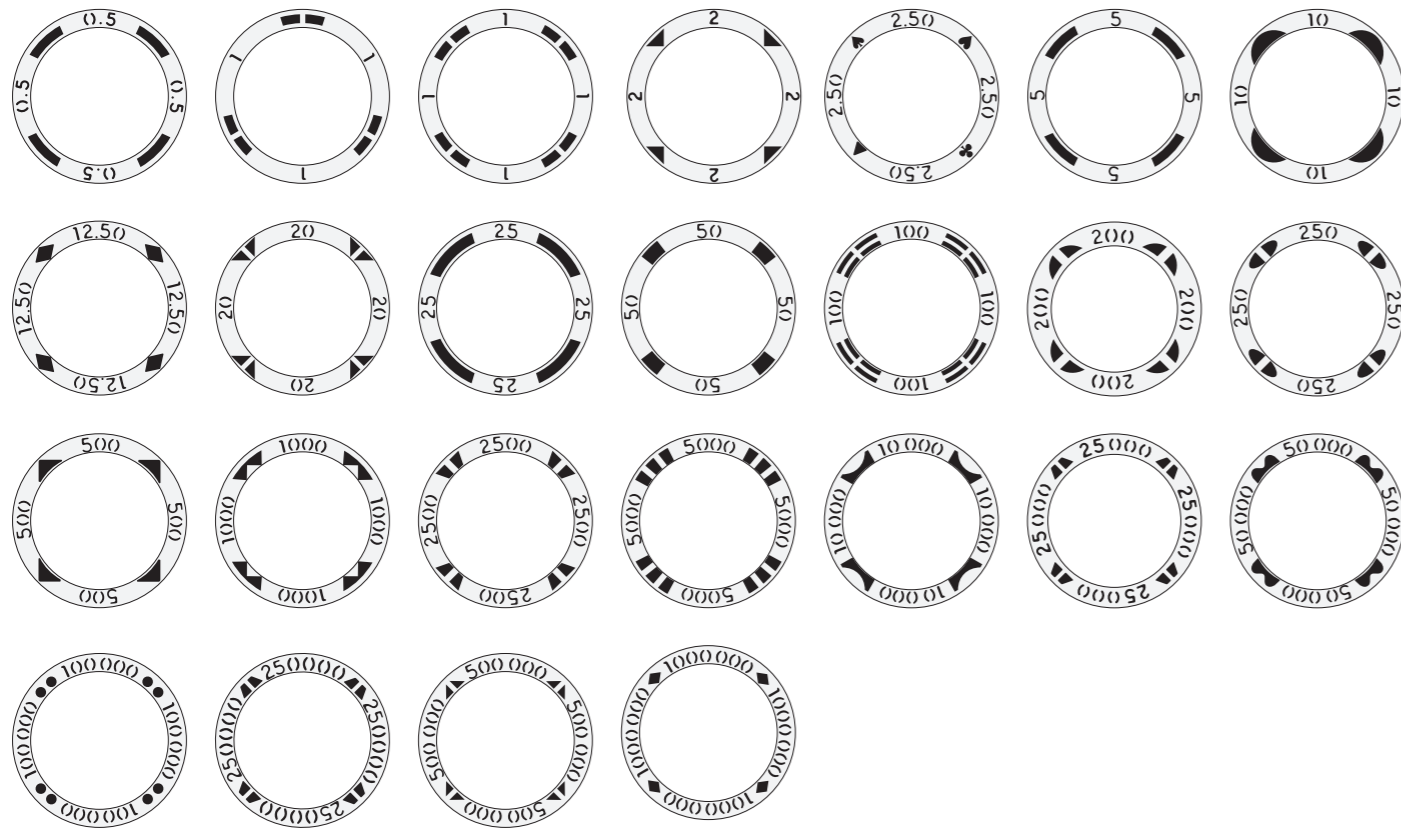

**€ Inner Ring Designs 40/43/45 mm** Decal 23mm ONLY

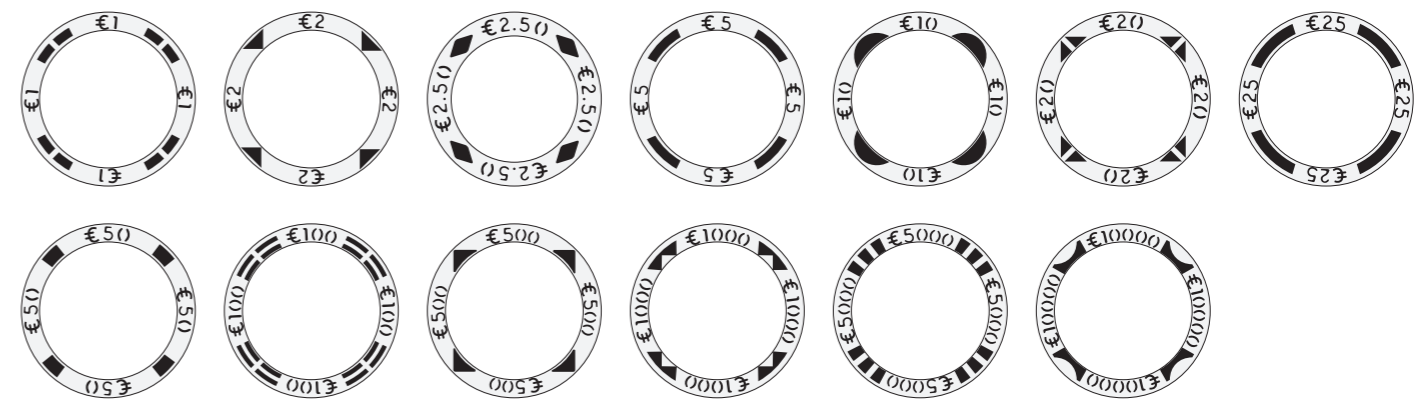

**Inner Ring Designs 50 mm** Decal 23mm CC650-A, CC660-A, CC660-C ONLY



**\$ Inner Ring Designs 40/43/45 mm** Decal 23mm ONLY

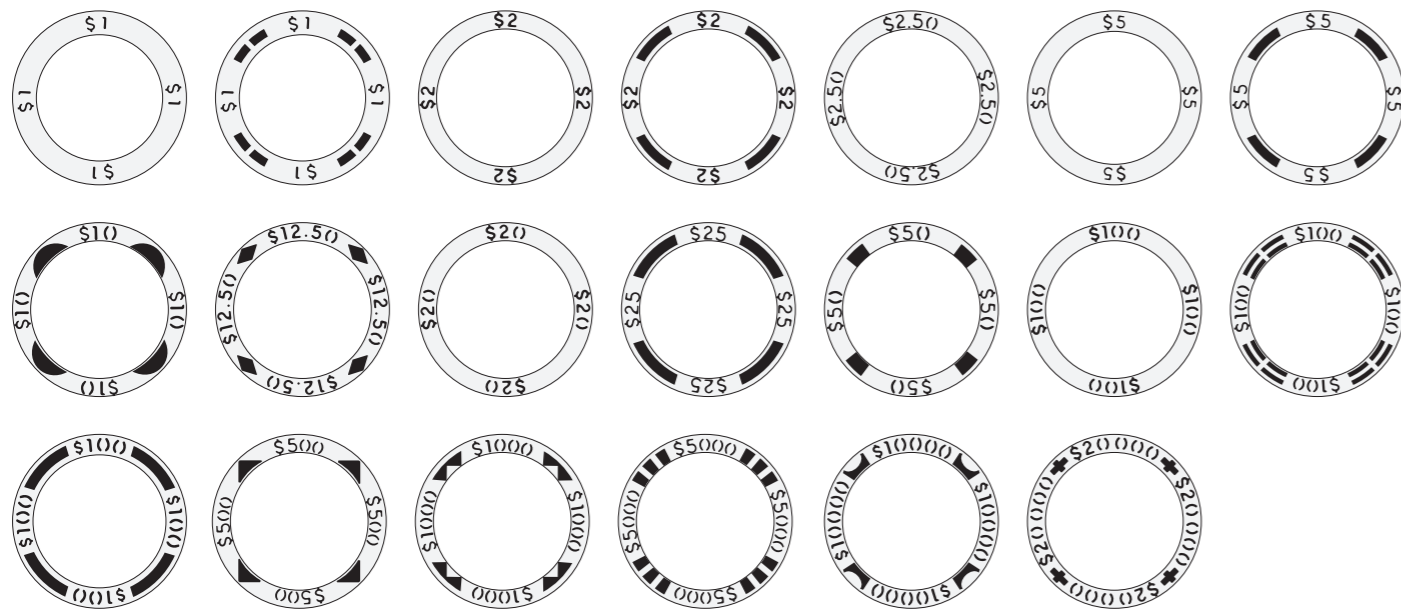

**Inner Ring Designs 50 mm** Decal 30mm CC650-B, CC660-B, CC660-D ONLY

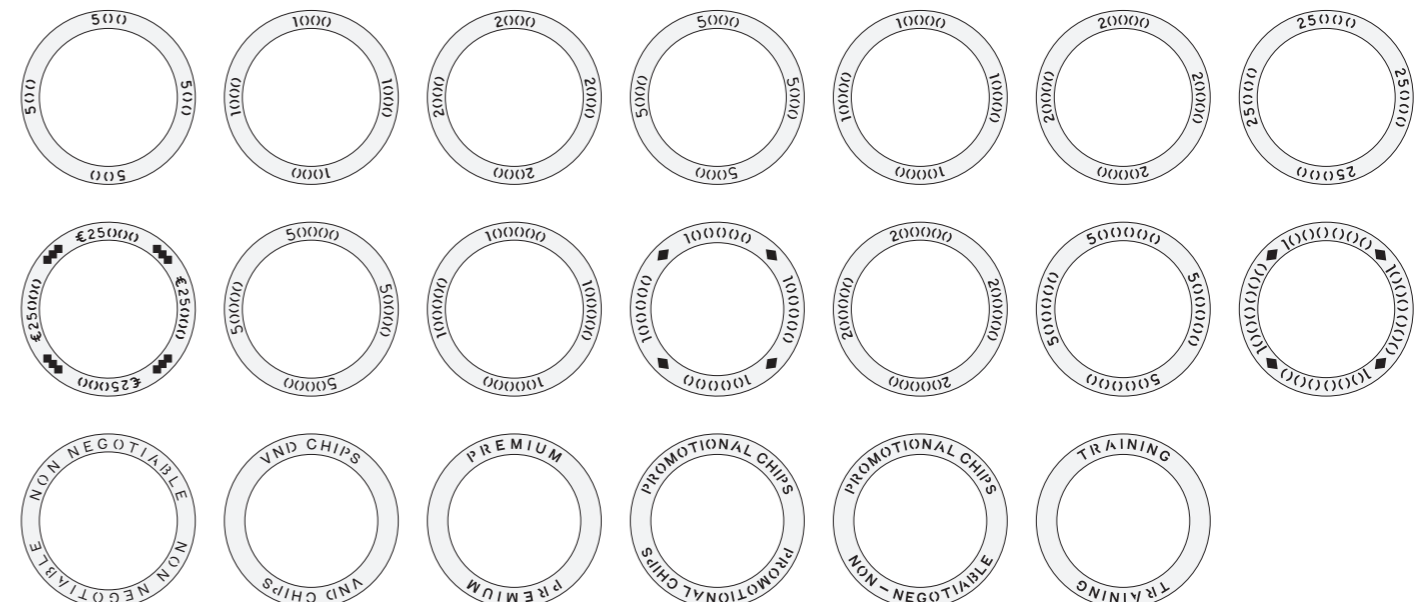

# EDGE INSERT STYLE Decal Value Chips

Explore our latest chip collection, crafted for ultimate customization and style. Choose a mould with or without edge inserts to suit your design preferences. For chips with a 23mm decal, elevate your design by adding a custom inner ring or selecting from Matsui's extensive range of standard inner rings. Create unique combinations tailored to your needs and make your designs truly stand out.

## Edge Insert

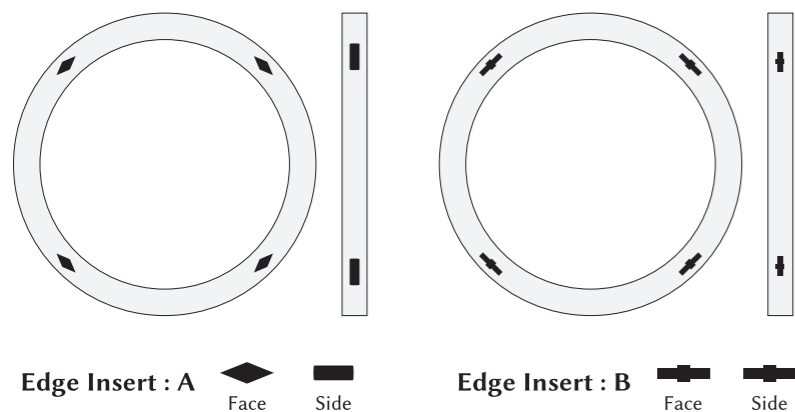

## 43 mm 2 colour

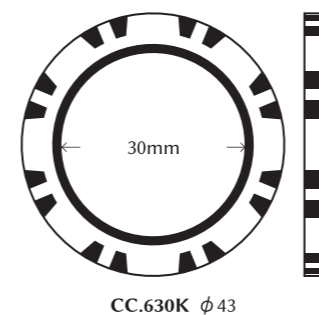

AVAILABLE WITH  
• Edge Insert A, B

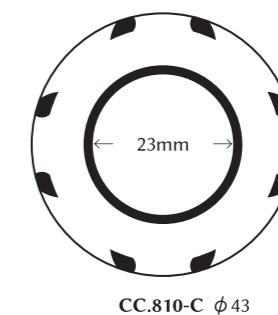

AVAILABLE WITH  
• Edge Insert A, B  
• Inner Ring

## 43 mm 3 colour

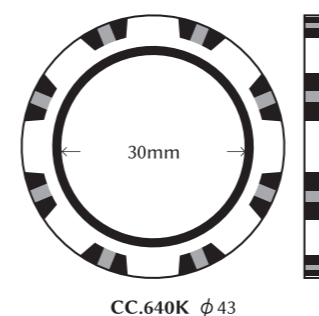

AVAILABLE WITH  
• Edge Insert A, B

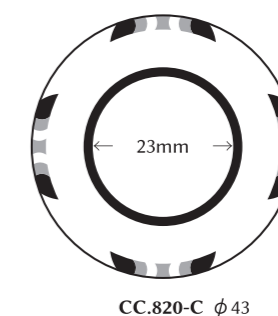

AVAILABLE WITH  
• Edge Insert A, B  
• Inner Ring

## 40 mm 2 colour

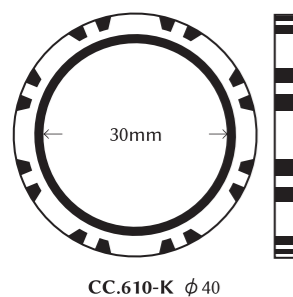

AVAILABLE WITH  
• Edge Insert A, B

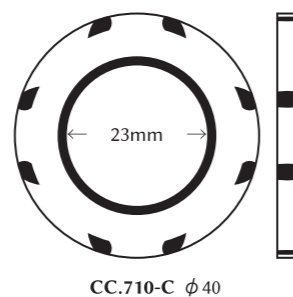

AVAILABLE WITH  
• Edge Insert A, B  
• Inner Ring

## 45 mm 2 colour

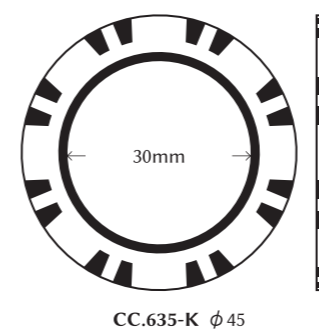

AVAILABLE WITH  
• Edge Insert A, B

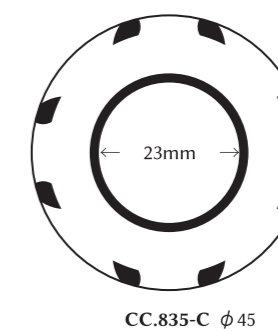

AVAILABLE WITH  
• Edge Insert A, B  
• Inner Ring

## 40 mm 3 colour

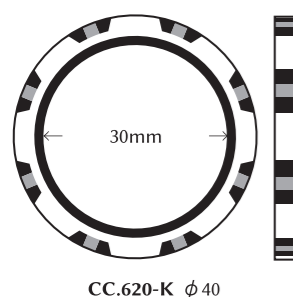

AVAILABLE WITH  
• Edge Insert A, B

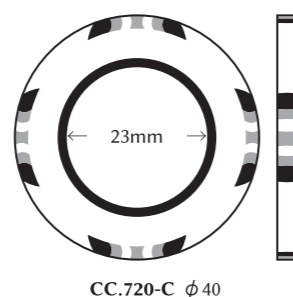

AVAILABLE WITH  
• Edge Insert A, B  
• Inner Ring

## 45 mm 3 colour

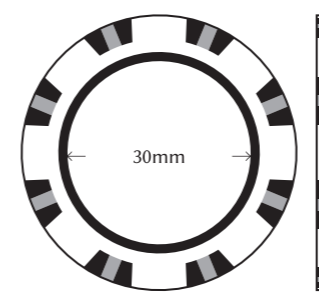

AVAILABLE WITH  
• Edge Insert A, B

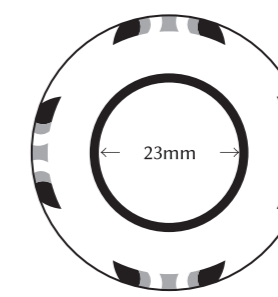

AVAILABLE WITH  
• Edge Insert A, B  
• Inner Ring

# HEAVY WEIGHT INNER RING STYLE Decal Value Chips

## 40 mm 2 colour

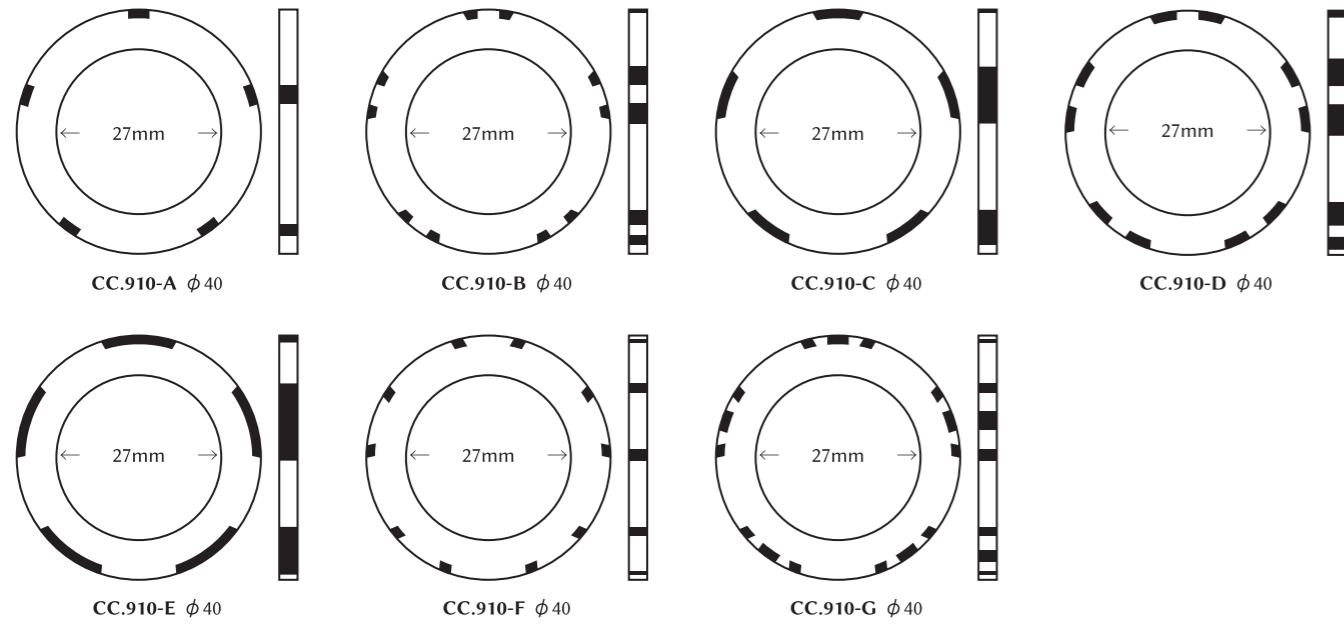

## 40 mm 3 colour

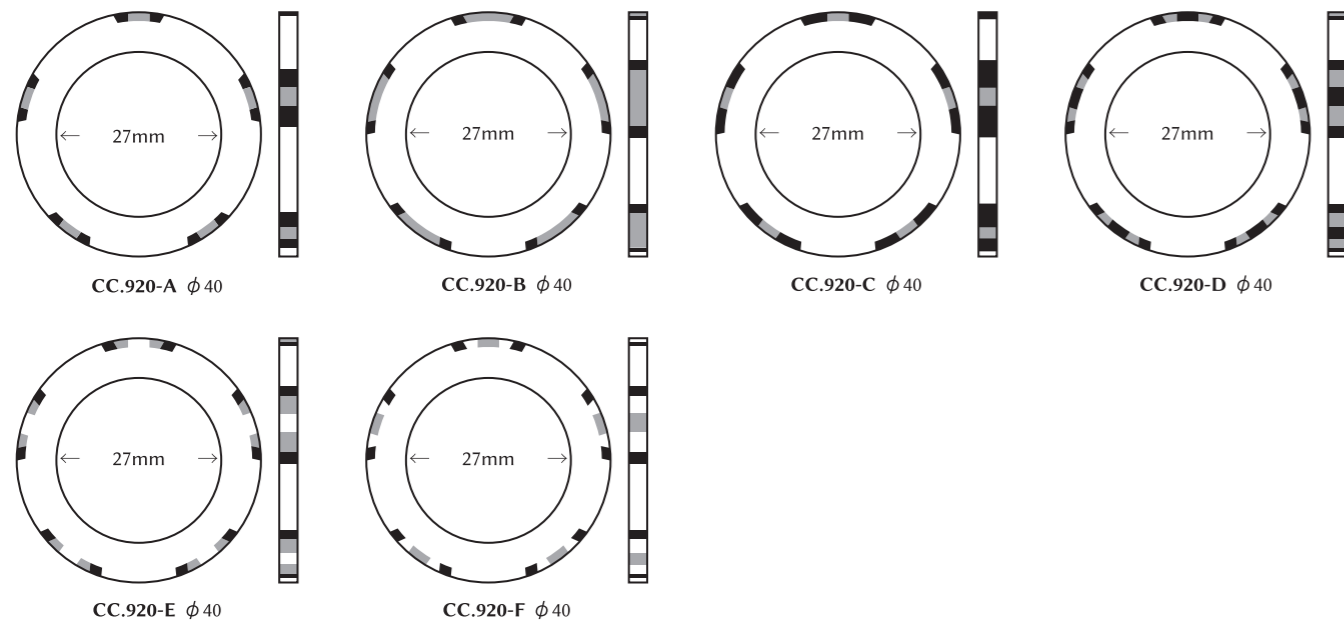

## 40 mm 4 colour

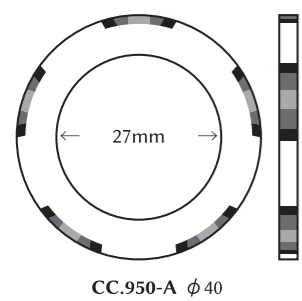

## 43 mm 2 colour

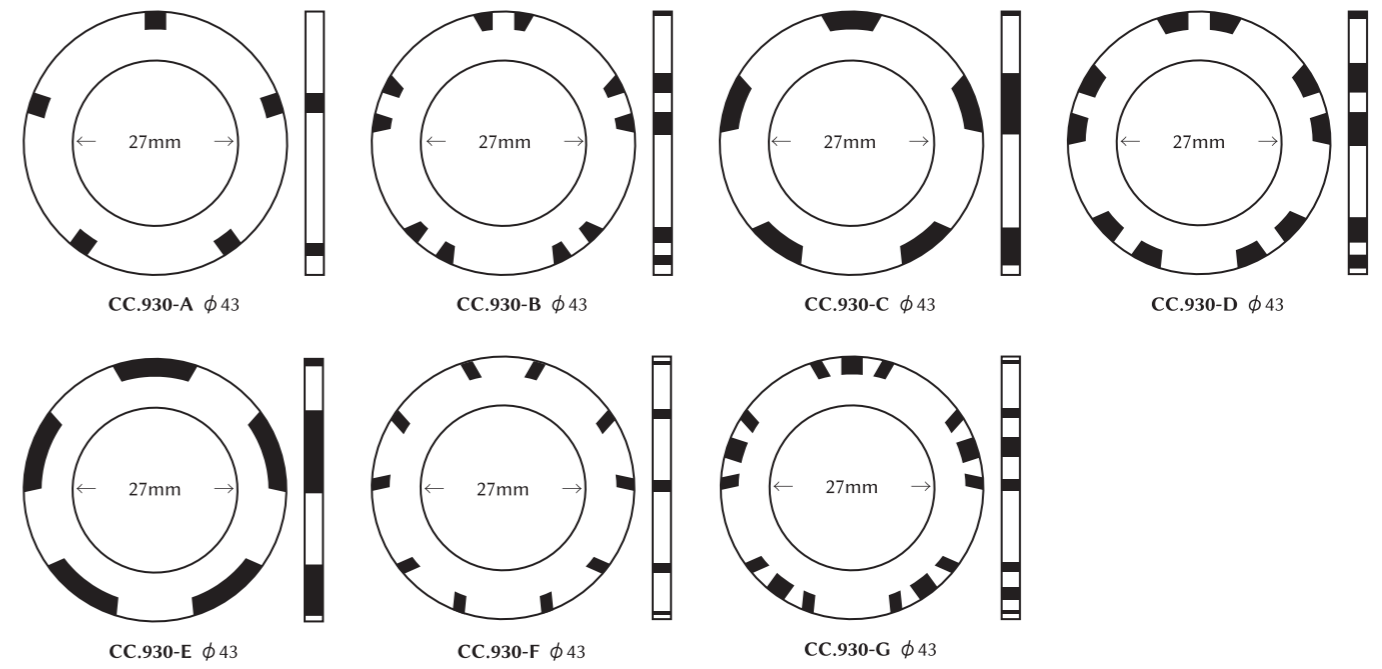

## 43 mm 3 colour

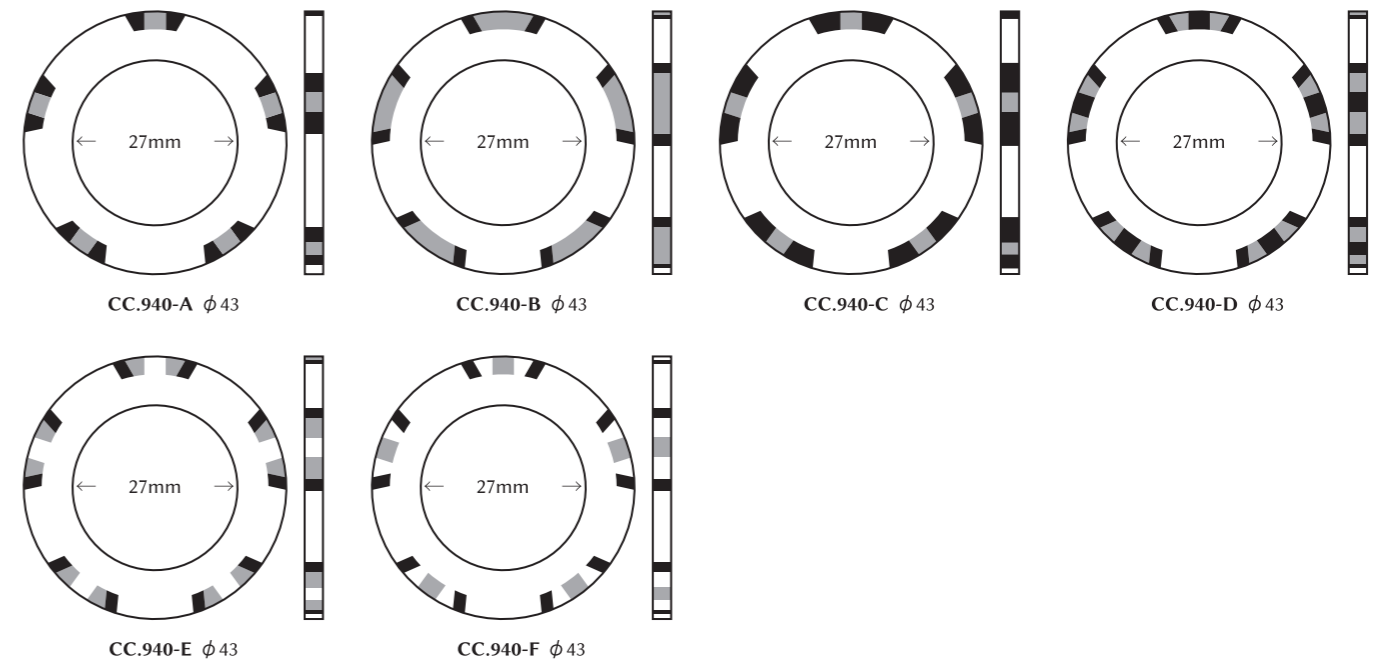

## 43 mm 4 colour

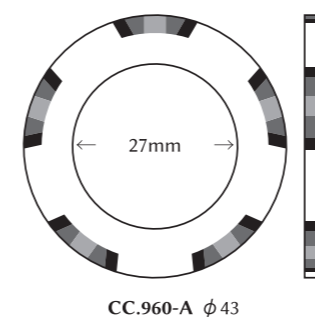

45 mm 2 colour

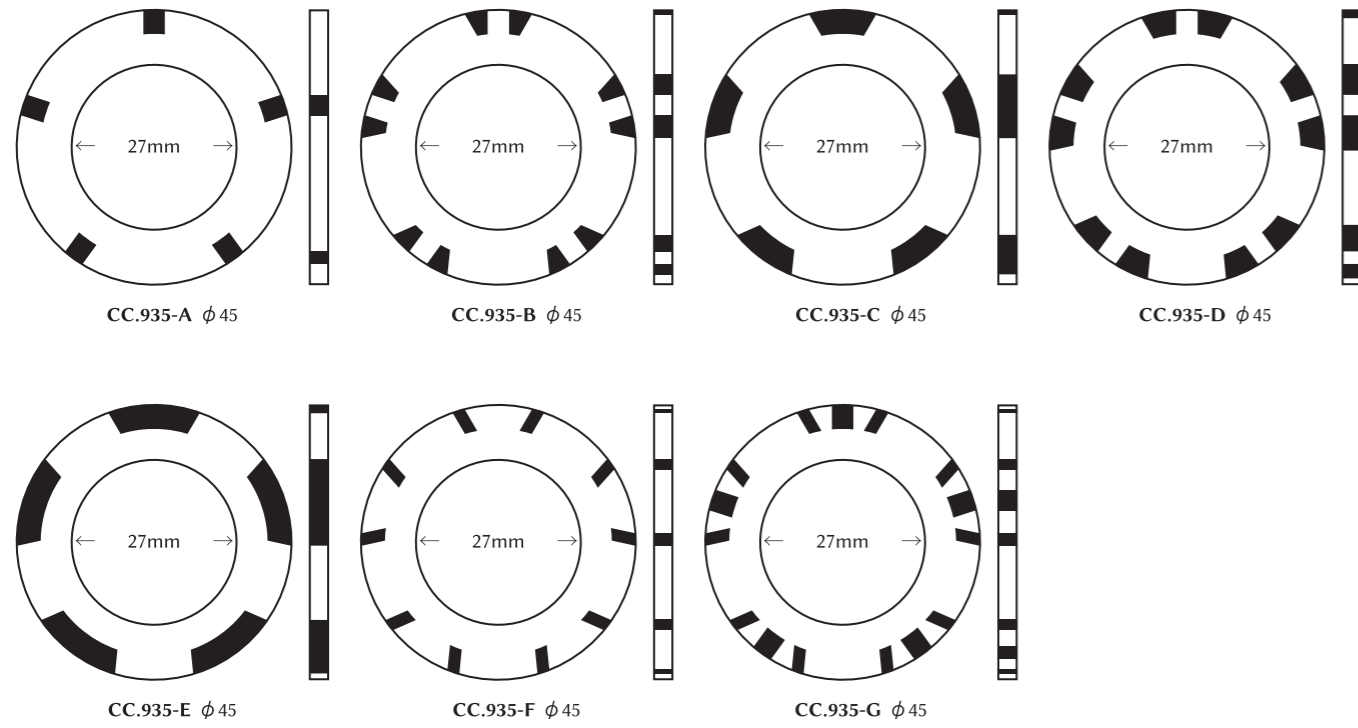

45 mm 4 colour

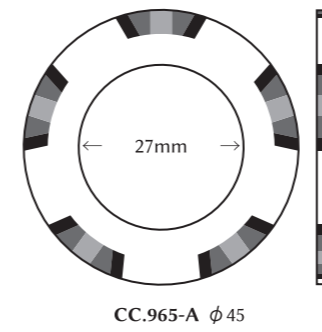

HEAVY WEIGHT INNER RING STYLE INNER RING

45 mm 3 colour

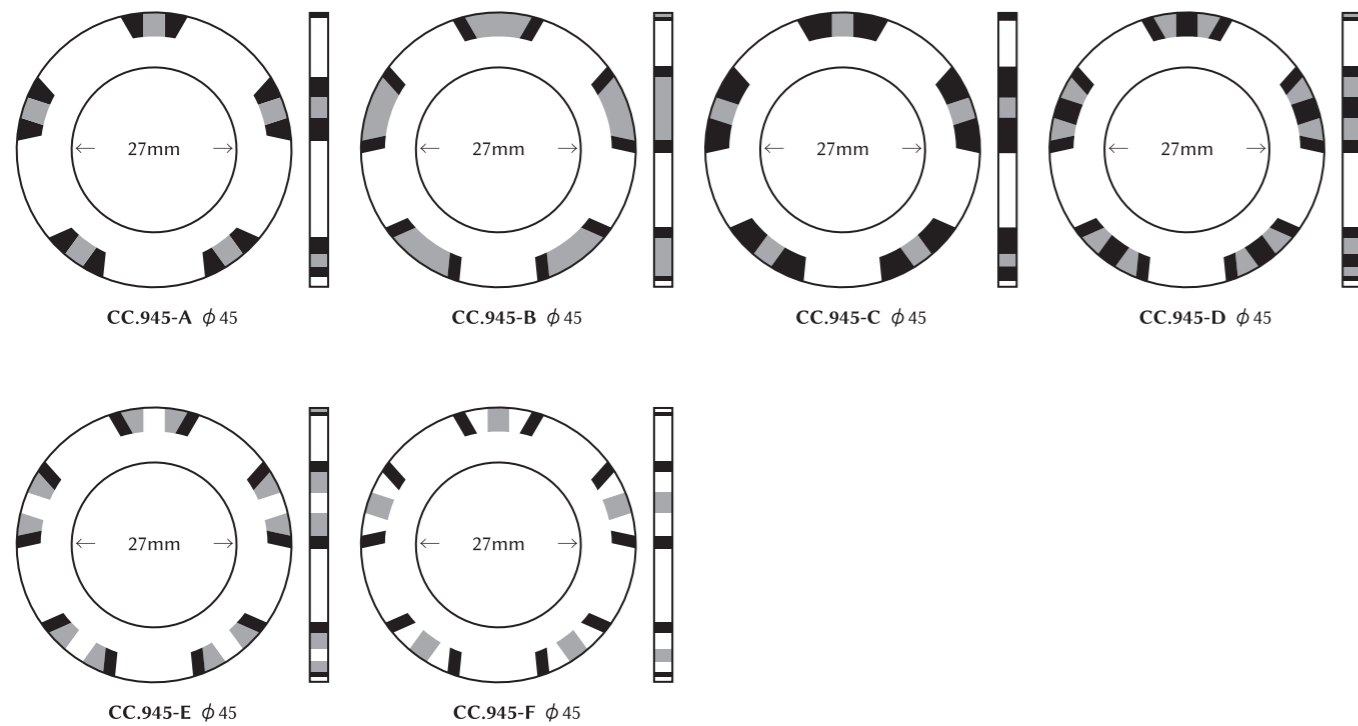

Inner Ring Designs 40/43/45 mm Decal 27mm ONLY

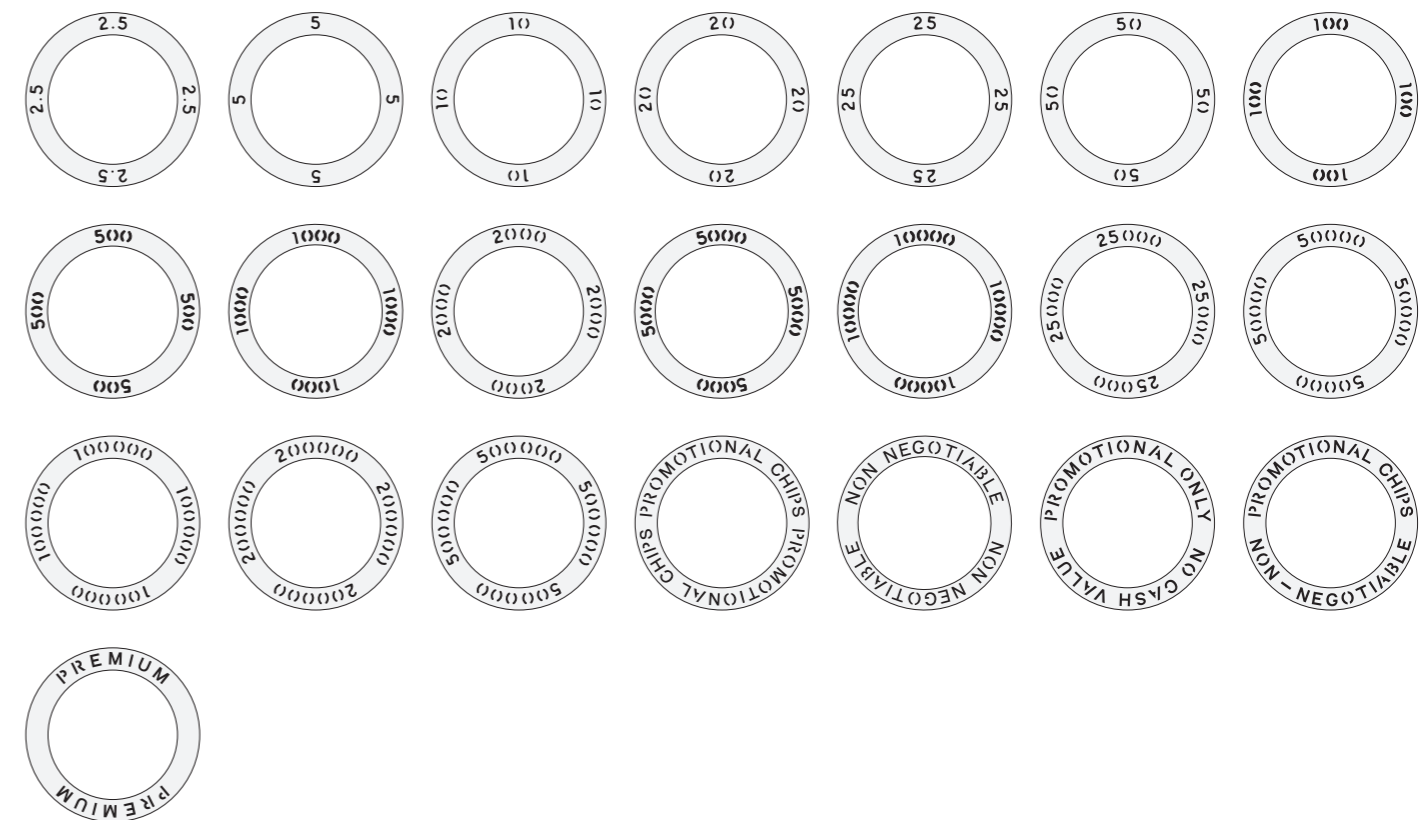

# DECAL VALUE Chips

With Matsui chips going through numerous precision moulding techniques and quality control procedures, our chips feel perfect in weight and texture. With 50+ different colors to choose from, there's sure to be a colour combination to suit your taste and security requirements.



## 40 mm 2 colour

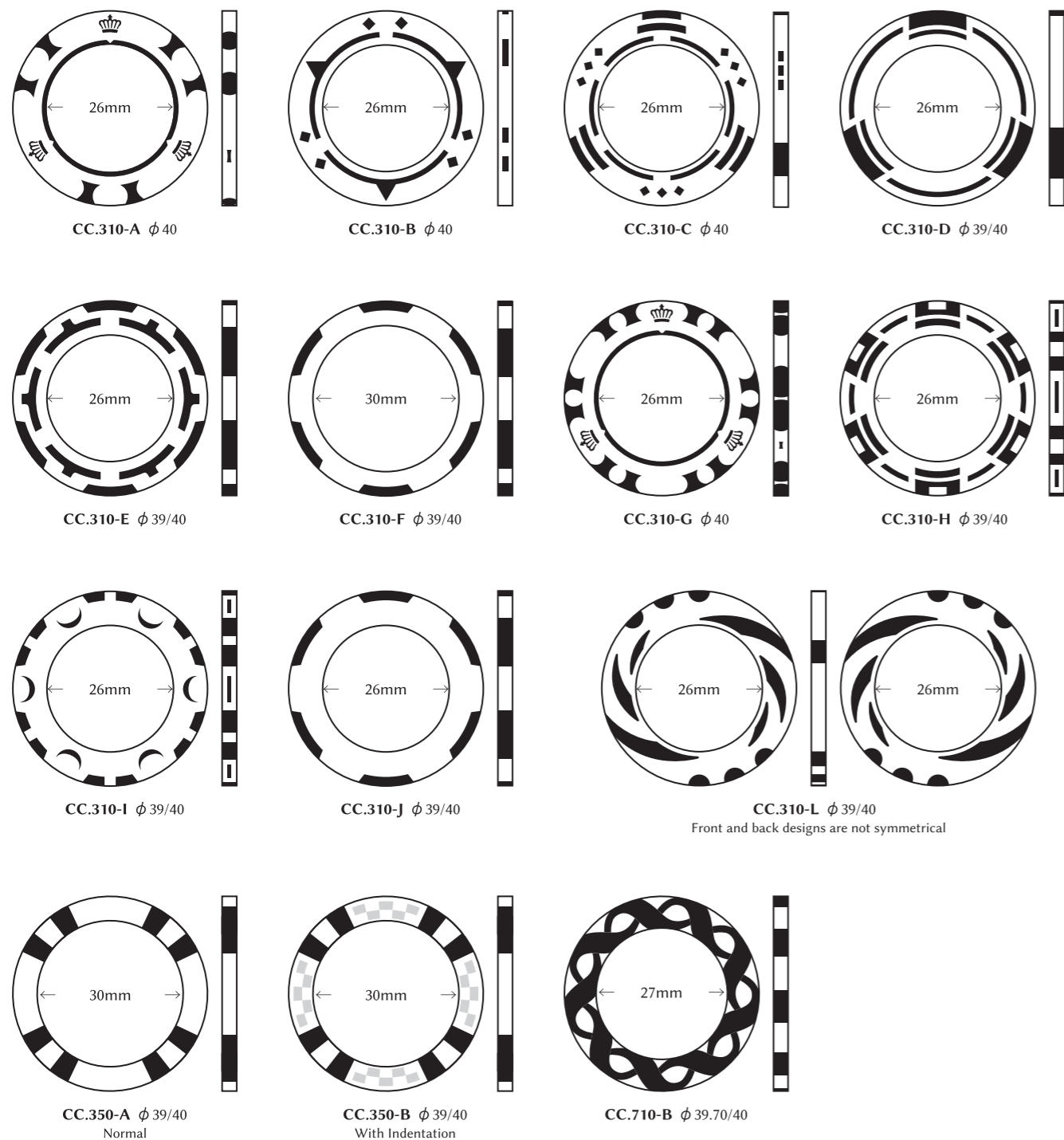

## 40 mm 3 colour

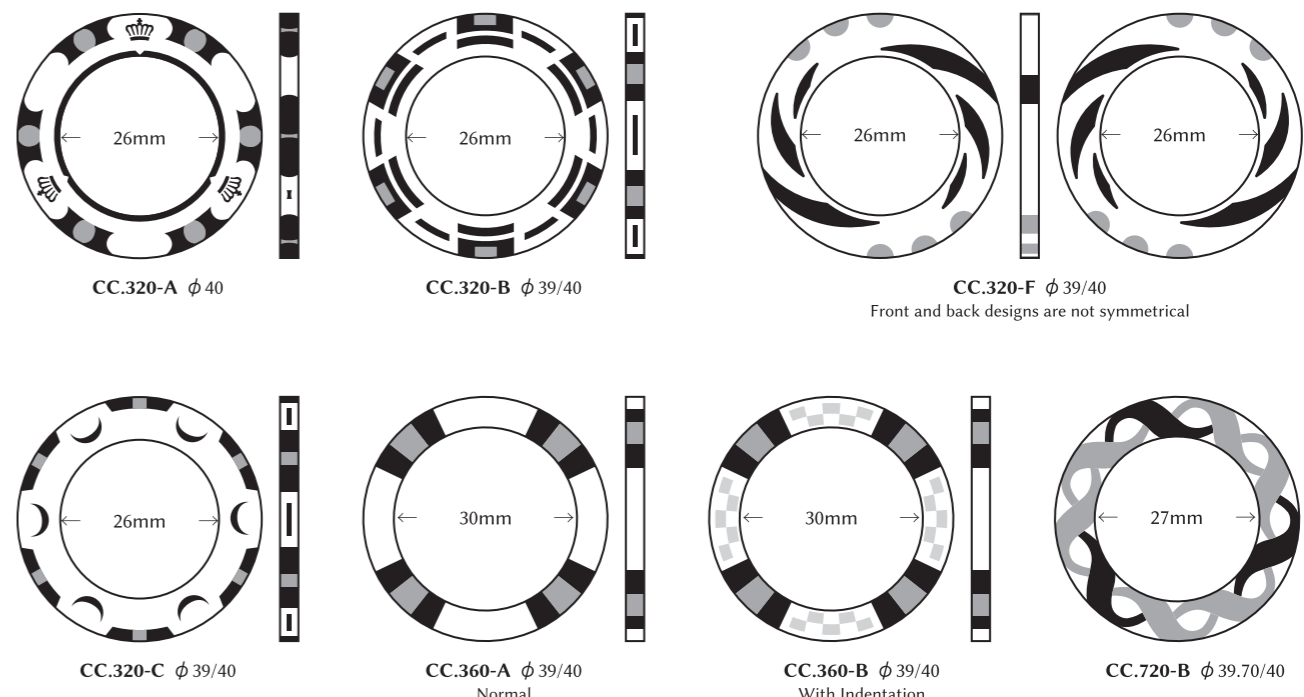

## 40 mm 4 colour

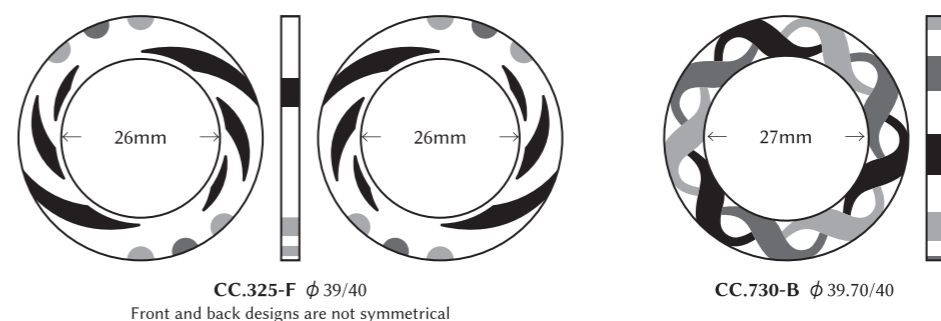

## 40 mm 1 colour

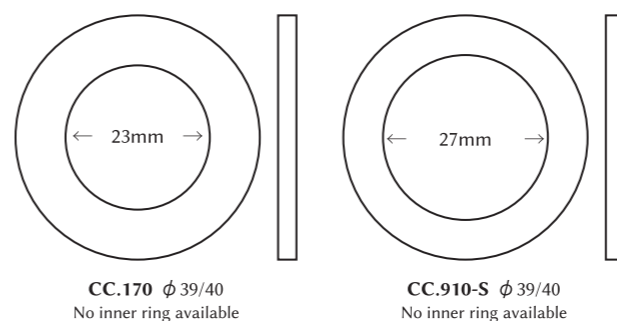

43 mm 2 colour

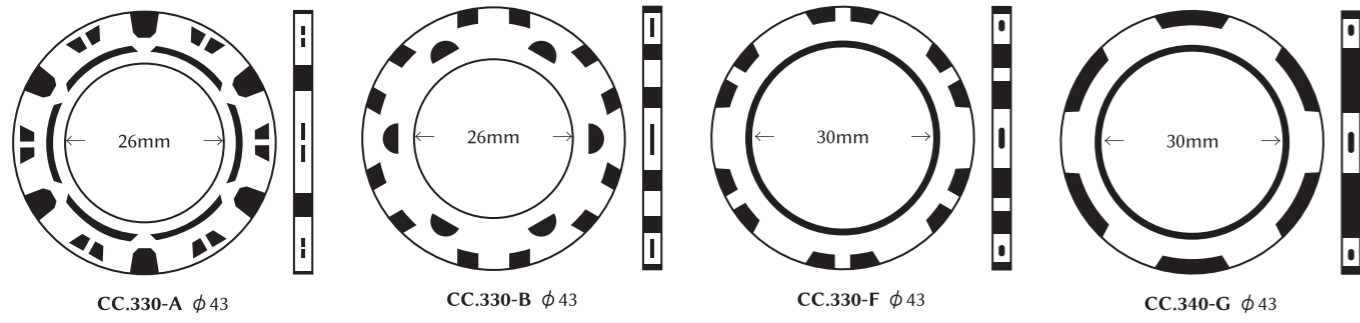

45 mm 2 colour

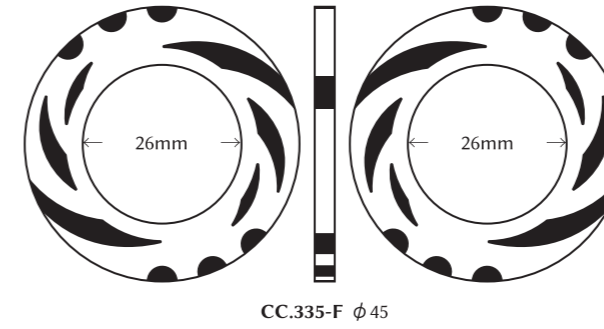

43 mm 3 colour

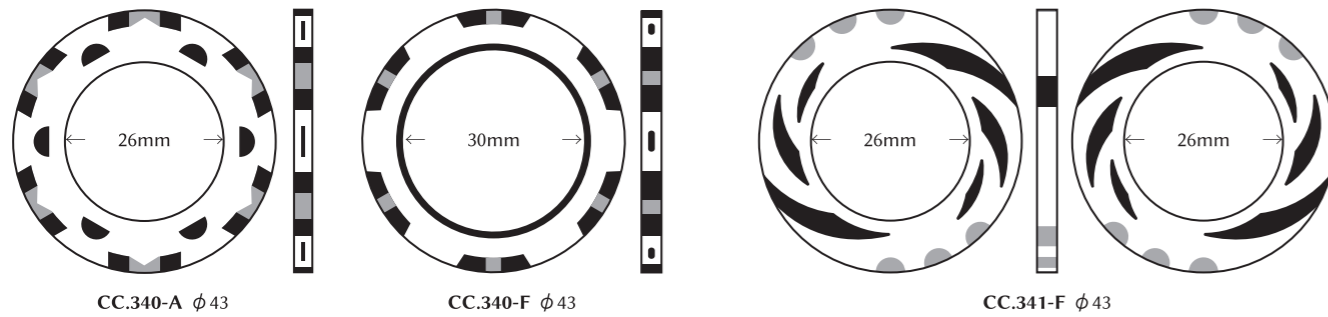

45 mm 3 colour

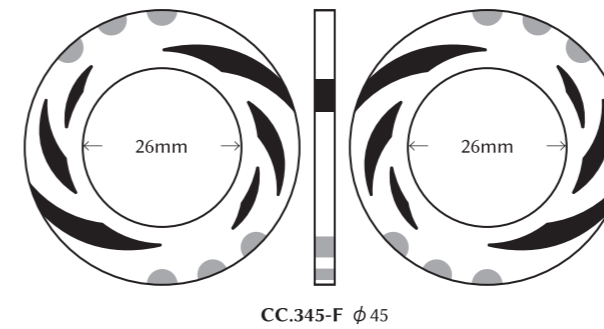

43 mm 1 colour

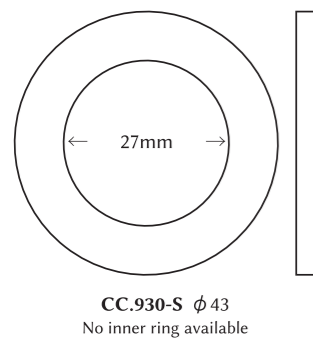

45 mm 1 colour

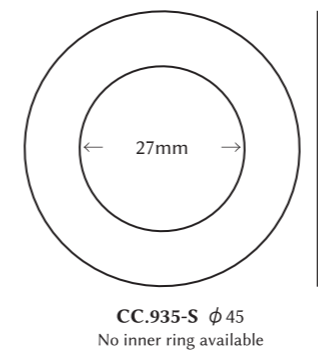

**CHIP COLOUR COMBINATION**

**ADDITIONAL DESIGNS**

- Glitter • Mirror Silver or Gold • Serial Numbers
- Hologram

**SECURITY OPTION**

- Visible UV • Invisible UV • MG EYE Security Printing
- MG EYE Edge • Laser Trace • Mould UV • EM Tag
- RFID

CIRCULAR EDGE DECAL 40 mm 2 colour

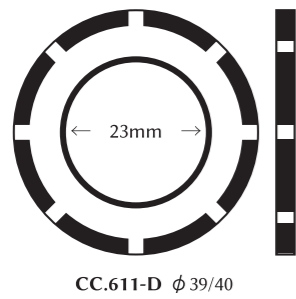

CIRCULAR EDGE DECAL 40 mm 3 colour

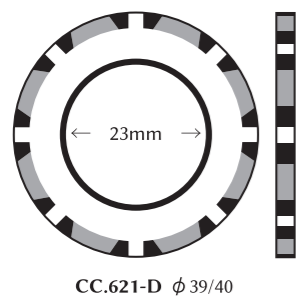

CIRCULAR EDGE DECAL 43 mm 2 colour

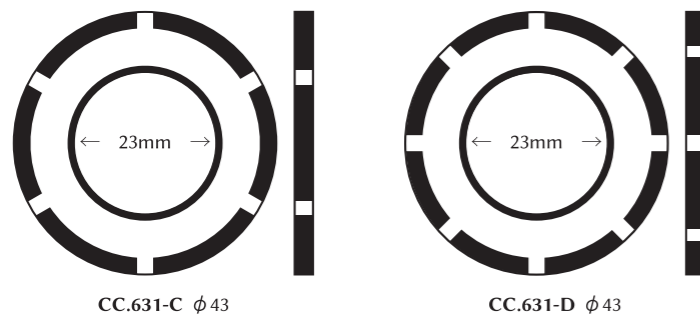

CIRCULAR EDGE DECAL 43 mm 3 colour

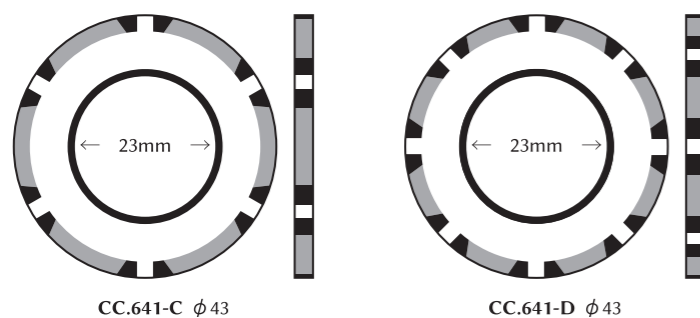

# HOTSTAMP & PAD Printing Chips

Ideal for low end value chips, the centre hotstamp design can be customized to your requirements. The hotstamp and PAD printing is also available in various colours.



1 colour Hotstamp and Pad Printing Chip

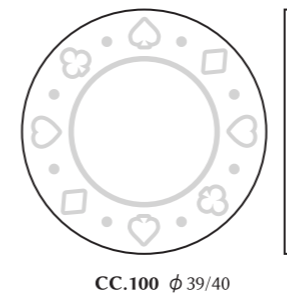
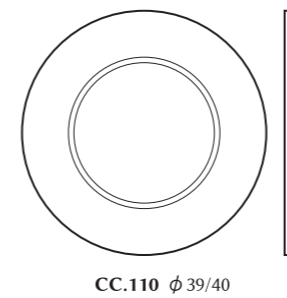

2 colour Hotstamp and Pad Printing Chip

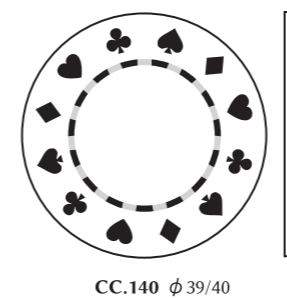

# WHEELCHECKS

High quality and extremely durable MATSUI wheelchecks. Please contact a sales representative to discuss your design ideas.



## Decal Wheelchecks

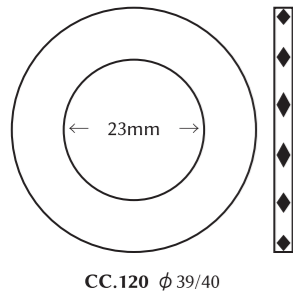

CC.120  $\phi$  39/40

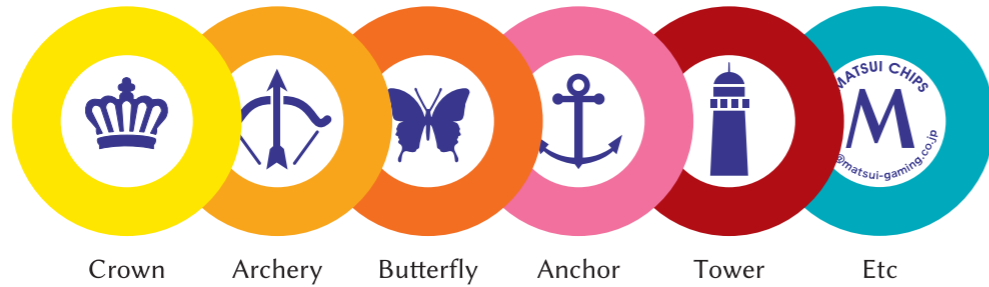

Crown Archery Butterfly Anchor Tower Etc

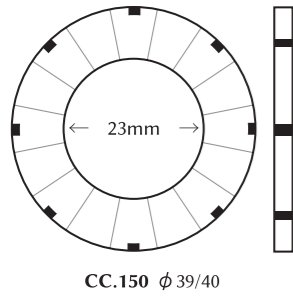

CC.150  $\phi$  39/40

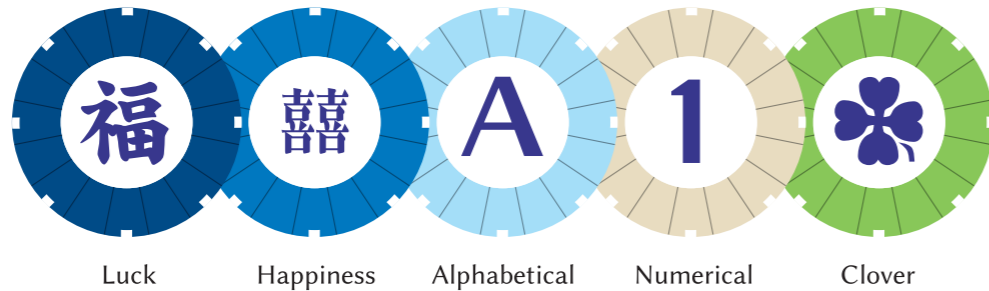

Luck Happiness Alphabetical Numerical Clover

## Moulded Wheelchecks

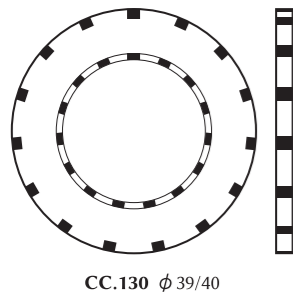

CC.130  $\phi$  39/40

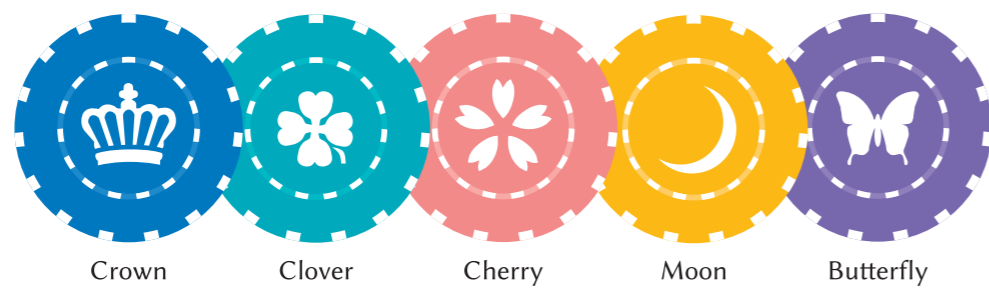

Crown Clover Cherry Moon Butterfly

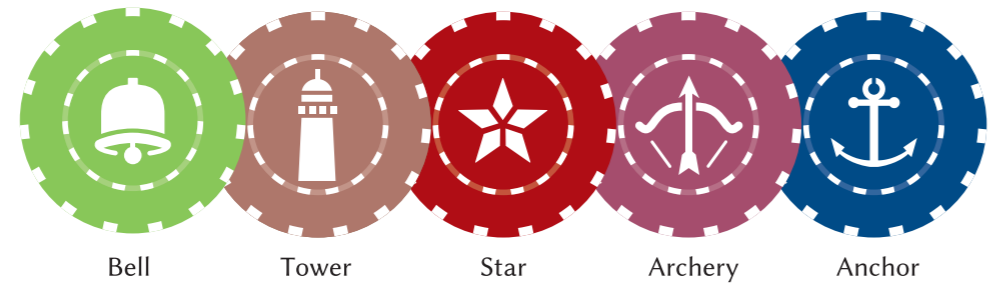

Bell Tower Star Archery Anchor

## CC120/CC150 Standard Decal Design

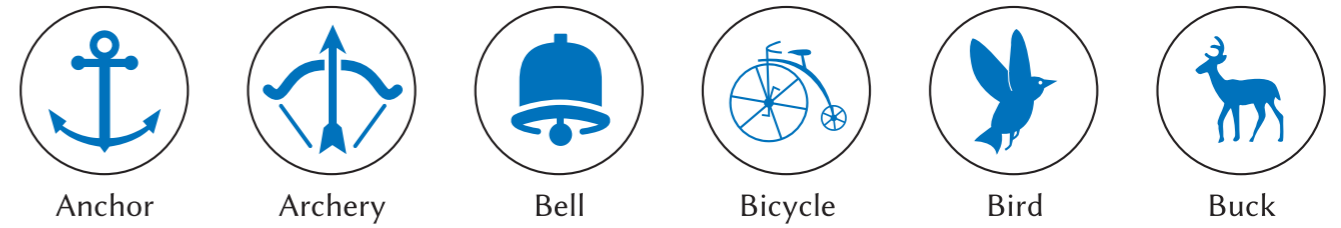

Anchor Archery Bell Bicycle Bird Buck

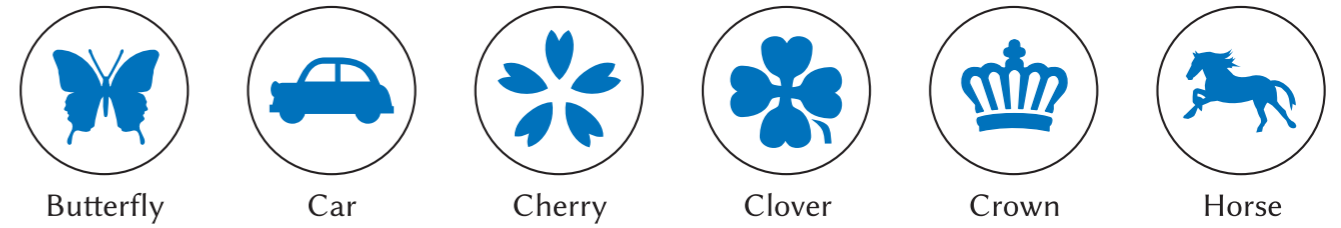

Butterfly Car Cherry Clover Crown Horse

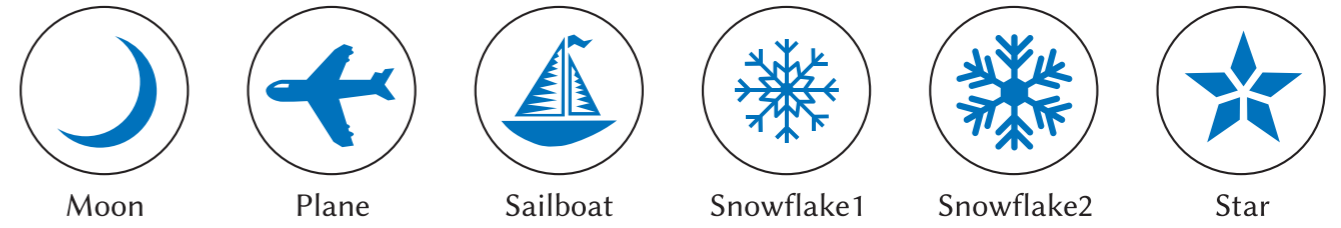

Moon Plane Sailboat Snowflake1 Snowflake2 Star

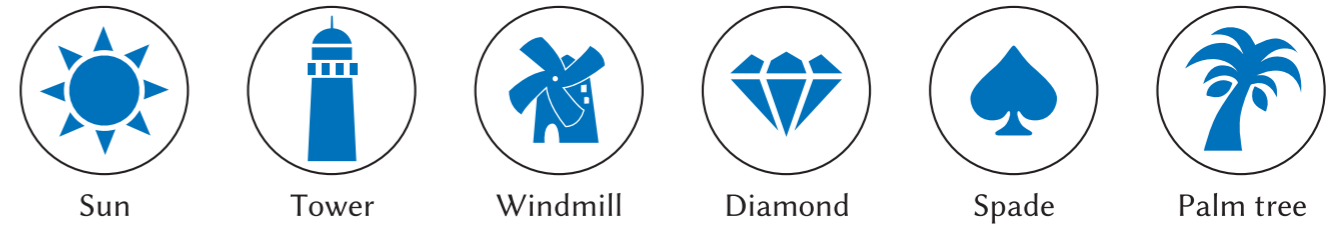

Sun Tower Windmill Diamond Spade Palm tree



Double Happiness Good Fortune Good Fortune Wealth Long Life Lucky



Lucky Plenty Prosperity

### CC120/CC150 Standard Decal Design



## ACRYLIC PLAQUES & JETON

Adding to our already established range of high quality gaming chips, the MATSUI group are now pleased to offer Plaques & Jetons to the casino market. Available in virtually all shapes and sizes with reassurance of different security features.



### Rectangle



**SIDE PRINT**  
NOW available in various colors for Rectangle / Corner Cut plaques

### Rectangle (corner cut)



### Oval



### Jeton



**Size** We can cut PLAQUES and JETONS to any size or shape from our extensive range.

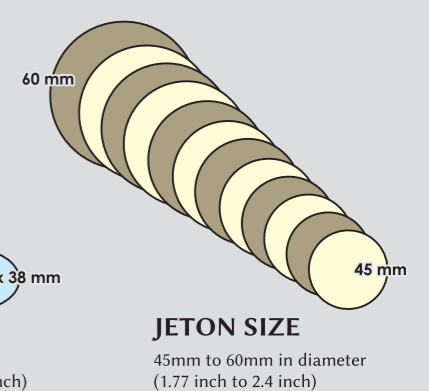
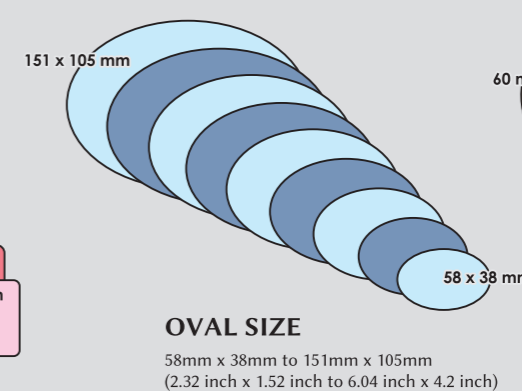

# Inner Ring Style PREMIER DECAL CHIPS

Our latest innovation for the gaming industry is the Premier Decal Chip. It has the shape and size of a plaque, but the weight and feel of a high value chip. The ordering process is simple, just choose your base, second and third color, as you would do for your chip. Then for a more eye-catching effect, you can select from our many decal glitter options. We also offer a wide range of security features. Please contact your local sales representative for more information.



# Inner Ring Style PREMIER DECAL CHIPS OVAL



68 mm x 48 mm 3 colour

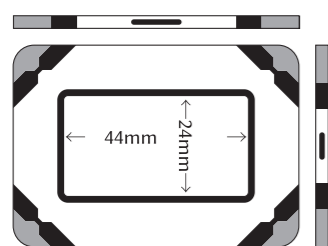

CC.870-A 68 x 48

82 mm x 57 mm 3 colour

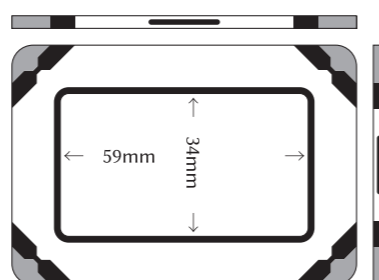

CC.870-B 82 x 57

68 mm x 48 mm 4 colour

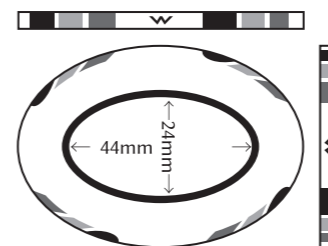

CC.880-A 68 x 48

82 mm x 57 mm 4 colour

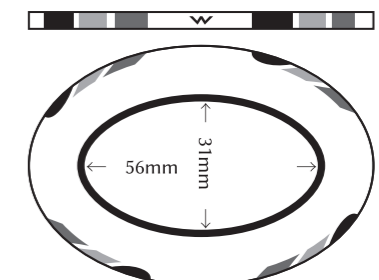

CC.880-B 82 x 57

95 mm x 66 mm 3 colour

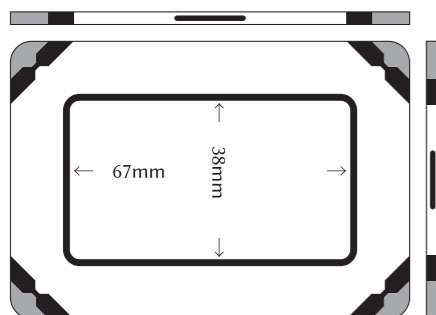

CC.870-C 95 x 66

## CHIP COLOUR COMBINATION



\*Inner Ring to be same colour as 2nd colour

95 mm x 66 mm 4 colour

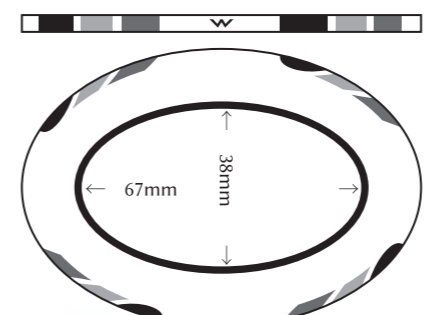

CC.880-C 95 x 66

## CHIP COLOUR COMBINATION



\*Inner Ring to be same colour as 2nd colour

## INNER RING DESIGNS

20	25	50	100
250	500	1000	2500
5000	10 000	20 000	25 000
50 000	100 000	250 000	500 000
N.N			

### CC.870-B, CC.870-C ONLY

1000 000	NON NEGOTIABLE
JUNKET CHIPS	
TOURNAMENT ONLY	NO CASH VALUE
Set Inner Ring	

## INNER RING DESIGN

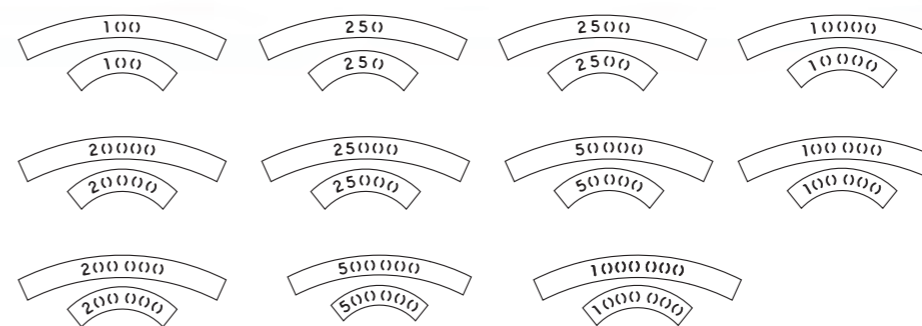

### CC.880-B, CC.880-C ONLY

NON NEGOTIABLE
----------------

## INNER RING CAN BE CUSTOMIZED

\*The ability to customize chips with your casino name is available.  
\*The inner ring colour is always the same as the second colour of your chip.



## INNER RING CAN BE CUSTOMIZED

\*The ability to customize chips with your casino name is available.  
\*The inner ring colour is always the same as the second colour of your chip.

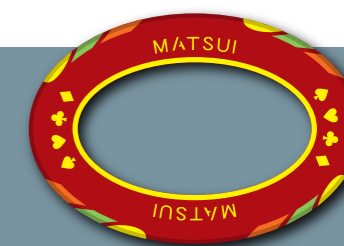

# COIN INLAY Value Chips & GOLD / SILVER Chips

MATSUI coin inlay chips and heavy-weight Gold / Silver Chips are highly polished and the centre part can be engraved to meet your design specifications. These chips are also available in assorted colour combinations.



## Coin Inlay Value Chips

### 40 mm 2 colour

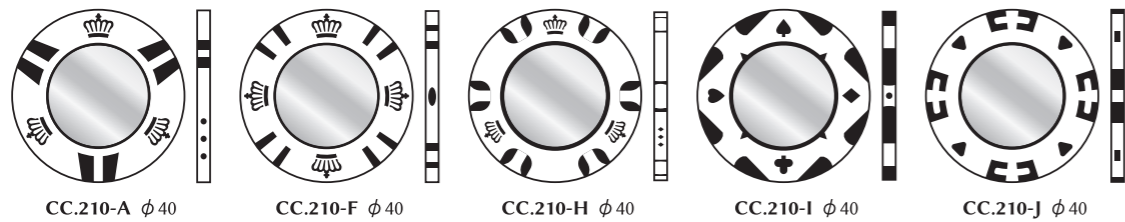

### 40 mm 3 colour

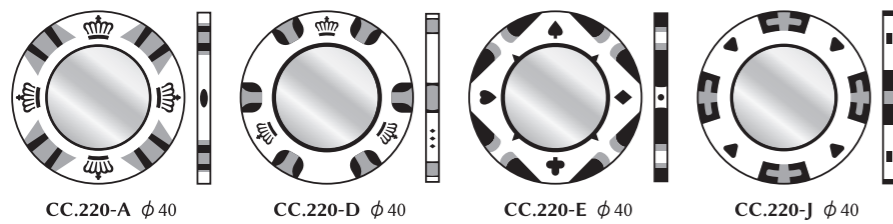

Silver Colour Gold Colour

**Coin Colours**  
Available in two different coin colours.

## Gold / Silver Chips

### 40 mm 2 colour

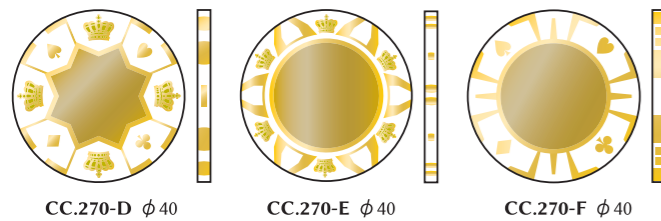

### 40 mm 3 colour

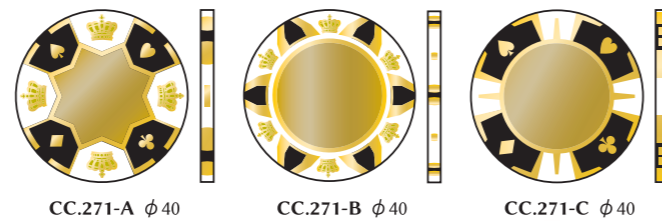

### 43 mm 2 colour

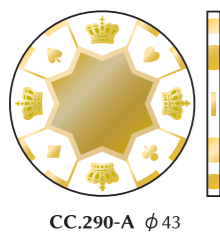

### 43 mm 3 colour



Silver Colour Gold Colour

**Base Colours**  
Available in two different base colours.

# ADDITIONAL Designs

With the growing demand for a variety of decal features, we have applied our production and gaming knowledge to give you an attractive range of design options.



## Glitter

Glitter decals can make a basic design look more attractive. Glitter rings, logos, letters or denominations are an effective way to make chips more eye catching. Numerous glitter design types are available, but only one type per chip design can be used.

### Glitter type

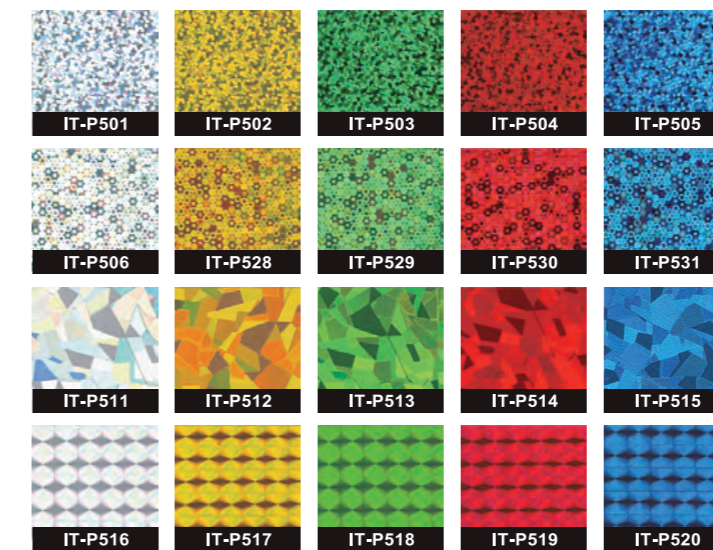

Glitter Ring type 1



Glitter Ring type 2



Glitter Logo



Glitter Base



Mirror Gold



Mirror Silver

## Mirror Silver or Gold

Mirror Silver or Gold can give a similar appearance to our (Silver or Gold) coin chips. This effect is created using our unique ink range.

## Serial Numbers

We can add serial numbers onto the rim of the chips, decal, coin inlay as well as our gold and silver chips.



Serial Numbers



Serial Numbers



Serial Numbers



Serial Numbers

## Hologram

Why not try our new hologram decal to make a more eye-catching design? The hologram design is now common on many bank notes and passports, due to the difficulty in trying to replicate hologram properties. If holograms are good enough for bank notes, then why not have them on your cash chips!

# SECURITY Feature

To protect your gaming currency, Matsui offers many different security options for your gaming chips. From standard UV Marking, original MG Eye to state of the art RFID technology, the security features are available in several different grade and complexity. These security make Matsui Chips one of the safest choice for casino operators for their gaming currency.



## UV Marking

### ◆ Invisible UV Marking

Green or red ultraviolet markings can be added to both chips and plaques to prove their verification. The markings that can also be customized are only visible under a UV light.



Invisible UV Marking

### ◆ Visible UV Marking

Silver or gold printwork of the decal can be UV reflected. The printed colours will glow green or red under a UV light.



Visible UV Marking

## SECURE-EM-CHIP / Anti-Theft

The actual loss of gaming chips through internal theft is difficult for anyone to measure. With the MATSUI Secure-EM-Chip you can feel safe in the knowledge that no chips will be removed from the gaming floor without detection.

### ◆ Contentment for Managers and Security

Casino management can have peace of mind knowing that gaming chips will not be taken off the gaming floor by casino without their specific authorization.

### ◆ Alarm Activated

When the chips pass through strategically placed security sensors, the alarm is activated. These chips can also be detected by hand held security devices.

#### • HOW IT WORKS

Electronic Magnetic (EM) material is applied to the inside of the gaming chip. This then generates an invisible electro magnetic field that can trigger an alarm when it passes through electronic detection gates. Most casinos have a route that staff members must follow off the gaming floor. By using MATSUI's superb EM Chip with EM Gate, you can ensure superb detection and stop all casinos gaming chip theft.



Amorphous Magnetic EM Chip



EM Gate

## Laser Trace

This is the best solution for a quick check of your chips. By adding our security material to the base colour of your chip, the unique laser pen will show if the chip is genuine. This is ideal for checking chips in the float tray. We achieve this by mixing special reactants with the raw materials without affecting the colour of the chips. They will appear the same as the normal chips. The colour of the laser depends on the base colour. This is mainly expressed in green, however it can also be expressed in red depending on the base colour chosen. The Laser trace is also available on the chip decal. This is applied to all of the printed surface.

#### • HOW IT WORKS



Detecting the chip's face (Green color)



Detecting the chip's face (Red color)



Detecting the chips in a stack or float tray



Laser option on the decal

## Mould UV

The UV security feature can be applied to the mould so that it can be identified through a special detector. Maintain the unique point color of the chips. Quick verification available in large quantities as features are applied to the point color part. The UV security feature should be applied to the 2nd or 3rd colour of the chip. \* There is a difference in the degree of emission by the color of the injected raw materials.



Detector



Before lighting



After lighting



## MG EYE SECURITY PRINTING

A unique decal printing method, exclusive to MATSUI, lets us create a gaming chip impossible to duplicate.

### ◆ MG EYE Scanner

When chips are projected by lens, a print with special ink will be shown on LCD screen. The production time is unchanged from that of non MG Eye chips, so all Matsui chips are delivered at exceptional lead time. This device is available to use with AC adaptor or battery. If you connect RCA cable to the output terminal, the vision of LCD screen will be able to project to external monitor.

### ◆ Specifications

MG EYE Scanner	
Dimension	63 (W) x 162 (L) x 70(H) mm
Weight (without battery)	190g
Power Consumption	DC5V / 620mA

AC Adaptor	
Voltage	Input AC100-240V Output DC5V/2A
Frequency	50/60Hz

### • HOW IT WORKS Invisible Print



### • HOW IT WORKS Visible Print



## MG EYE - EDGE

Available in all decal chips including Premier Decal Chips, security taggant specially developed for Matsui Chips can be added to base colour to your chips. The portable reader can check if the chip is genuine or counterfeit.

### ◆ Specifications

MG EYE EDGE Reader	
Dimension	59 (W) x 36 (L) x 14 (H) mm
Weight	23g
Power	Battery operated

### • HOW IT WORKS

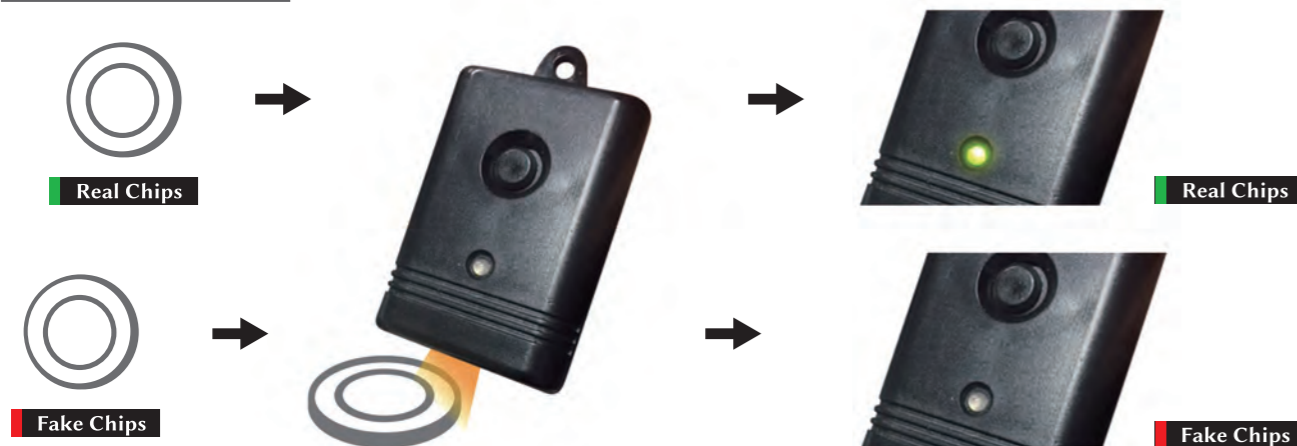

## RFID

Matsui 13.56 RFID Chips & System is the latest security system using radio frequency identification at 13.56Mhz. It's now possible to recognize a large volume of chips simultaneously under stable cash desk conditions. This will surely become an innovative new approach to your casino management. With these chips designed at 11g (weight) we then apply an electronic magnetic label to prevent robbery. This is based on the existing security environment. All the standard Matsui decal chips, plaques and jetons are now available with RFID.

It can protect your casino from counterfeit chips, whilst helping acquire information and confirmation about chip trading, stock situations and actual account of each table all in real time.



## Features

- ◆ HF RFID
  - Capable of recognizing many units quickly and at the same time.
  - Stable packaging structure and format safe from breakage.
- ◆ Grid Computing
  - Even when the chip is forged physically, the logic mechanism can perfectly control the chips.
  - Perfectly prevents information loss when there is hardware or network system trouble.
- ◆ Overcame RF Interference
  - Provides the hardware system with the algorithm which minimized the RF interface
  - Provides the method to control RF interference through software mechanism.
- ◆ Flexible Software System
  - Modules suitable for each system are provided that they can be easily operated with the existing casino management system (CMS)
  - The system is designed independently from RFID hardware.

## Expected Effects

- Prevention of forgery of casino chips
- Prevention of theft of casino chips
- Monitors various rule breaking activities in the casino
- Checks the stock of casino chips
- Real time monitoring casino trade status
- Real time settlement by each table
- Real time confirmation of betting, winning, and losing status for each customer



# PJM3.0 RFID™

WDTs is the world's largest supplier of RFID-enabled table games and casino cage solutions. Their products utilize patented PJM3.0 RFID technology to secure chip inventories, automate casino operations, support many configurable side bets, provide accurate player ratings, and capture player data for valuable business insights.



## Full Floor Automation with PJM 3.0™

At the core of WDTs' Perfect Pay™ smart table platform is Phase Jitter Modulation (PJM 3.0™) RFID — a breakthrough technology redefining how live table games are managed, protected, and optimized. Unlike conventional RFID systems that rely on signal strength, PJM 3.0™ encodes data through precise timing variations in the RF signal, delivering ultra-fast and highly reliable chip detection in high-density casino environments.

## Intelligent Tables. Measurable Results.

Perfect Pay™ transforms every wager into actionable intelligence. Each chip carries a universally unique ID(UUID), enabling real-time tracking of chip authentication, ownership, movement, and transaction status. Dealers operate faster, errors are reduced, and integrity is strengthened — while operators gain complete visibility across the floor.

## PROVEN FINANCIAL IMPACT

Automation increases game speed and table open time — while eliminating cheating, theft, and dealer error.

- Directly increases gross gaming revenue
- Expands market share
- Delivers ROI in under 12 months
- Improves performance without increasing foot traffic

Matsui is licensed to produce and supply gaming chips with PJM3.0 RFID. Matsui's PJM3.0 RFID chips have been already deployed and used by major operators all over the world. Please contact Matsui sales of your area.

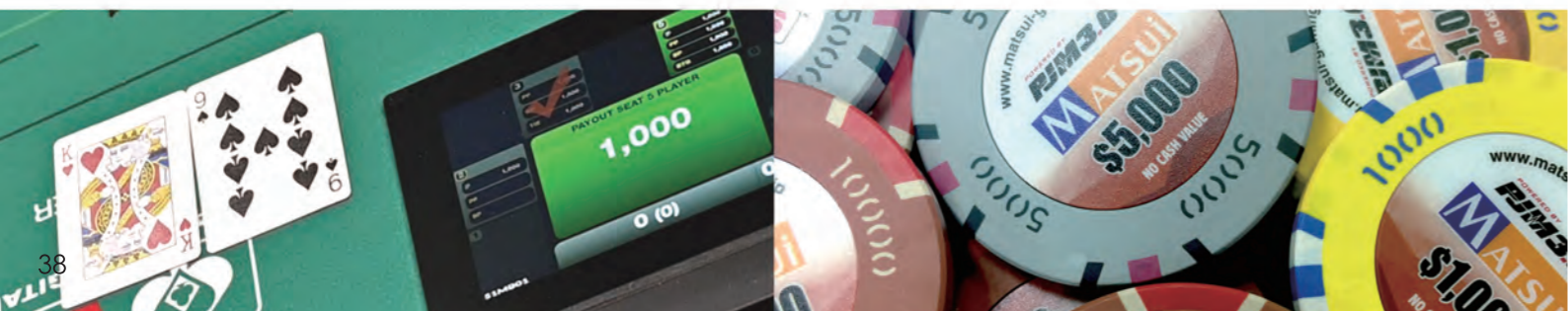

# SECURITY Manufacturing



The MATSUI complex on the outskirts of Seoul, Korea houses our purpose built chip manufacturing plant and modern offices. The manufacturing units and the dedicated staff are committed to increasing customer satisfaction through distribution of the world's highest quality gaming chips. This includes the customized marketing, careful design and precise production incorporating the latest innovative security features.

MATSUI uses a wide range of environmentally friendly materials. We also apply state of the art moulding techniques to manufacture the most accurately shaped and time tested gaming chips. The plant is extensively maintained, keeping a clean and temperature controlled environment, thus ensuring the quality of the chips are always kept to the highest possible standards.

The manufacturing units and the dedicated staff are committed to increasing customer satisfaction through distribution of the world's highest quality gaming chips. This includes the customized marketing, careful design and precise production incorporating the latest innovative security features.

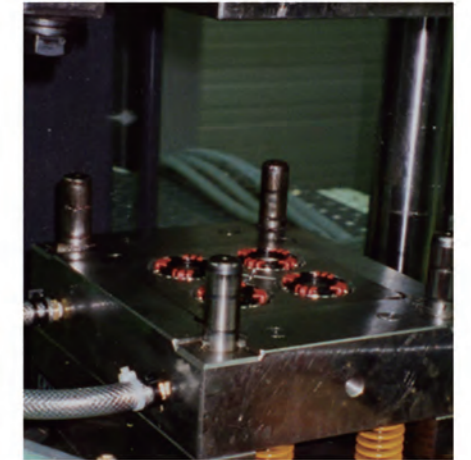

When producing gaming chips, security is one of the most vital aspects to be considered. MATSUI solves this issue using a variety of methods.

Top range security cameras cover both the manufacturing line and the outside of the complex. All chips and materials used during the manufacturing process are secured in vaults only accessible to authorised personnel and 24hr security guards are in place both inside and outside the plant.

These precautions guarantee that any product cannot be removed from the plant without authorised approval.

All gaming chips data is stored in a management controlled setting to ensure all data is secure and repeat orders can be readily accommodated.



# CHIP ACCESSORIES

We can supply full range of accessories related to gaming chips. At your gaming tables and also for cage and backyard, Matsui can support you through all the aspect of your operation.



**DISPLAY RACK**  
Tree style

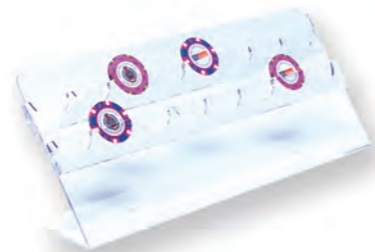

**DISPLAY RACK**  
for value chip cover



**FLOAT TRAY**  
12 tube / 15 tube / Single or Double



**CHIP CASE**  
accomodate 100pcs of 39~43mm chip,  
Stackable

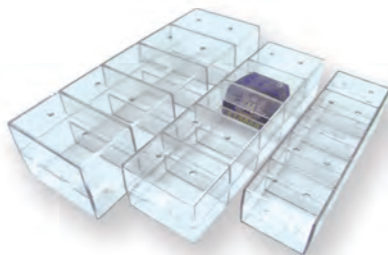

**PLAQUE CASE**  
Large (for 108x75mm)  
Medium (for 82x57mm)  
Small (for 68x48mm)



**ROULETTE VALUE CHIP COVER**  
with 2 locks



**CHIP CARRYING CASE**  
accommodates 8 x 100 chip trays  
accommodates 10 x 100 chip trays

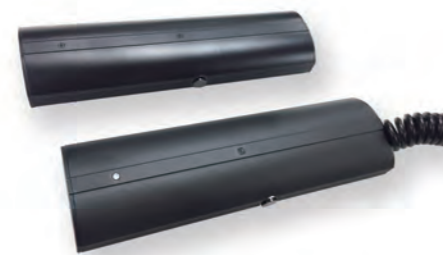

**UV LIGHT**  
w/cable or w/o cable



**HANDY LED UV LIGHT**  
Rechargeable

# TABLE LAYOUT

## SYNTHETIC LAYOUTS

Developed with the latest technology, our new Eternity Synthetic Layouts are extremely durable and long lasting. Printed with silk screens or by heat transfer, these highly durable and clear colour contrasts layouts will stand the test of time. Choose from over 25 standard base colours or customize your own design to create a unique, high quality layout specific to your requirements. Available in special table games. Pai gow, Three card poker, Bonus black jack, etc.



## Synthetic Layout Colour Chart

MW070501	MW070502	MW070503	MW070504	MW070505	MW070506	MW070507
MW070508	MW070509	MW070510	MW070511	MW070512	MW070513	MW070514
MW070515	MW070516	MW070517	MW070518	MW070519	MW070520	MW070521
MW070522	MW070523	MW070524	D-MUSTARD	BROWN	D-SAND	TAN

# ROULETTE (size: mm)

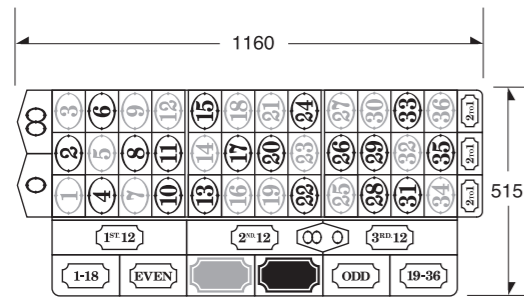

**WL.020** 2600 x 1600

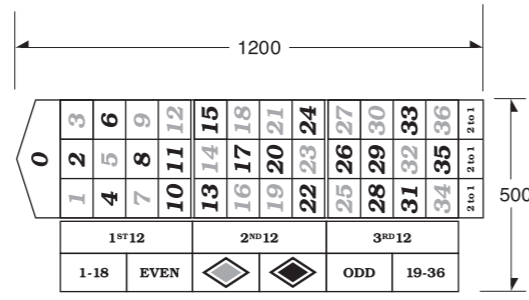

**WL.026** 2900 x 1600

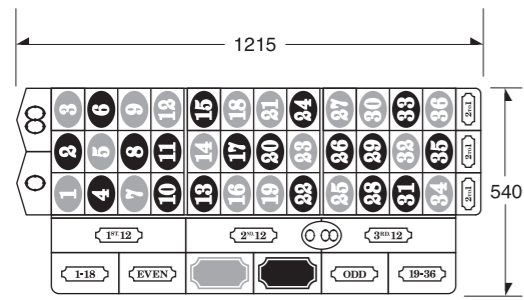

**WL.0202** 2900 x 1600

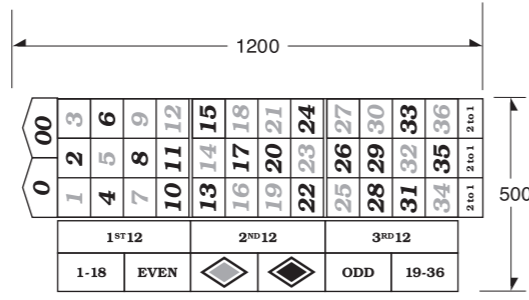

**WL.027** 2900 x 1600

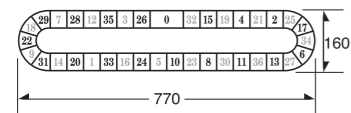

**RT-1**

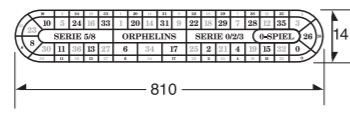

**RT-2**

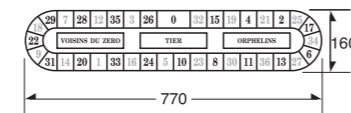

**RT-3**

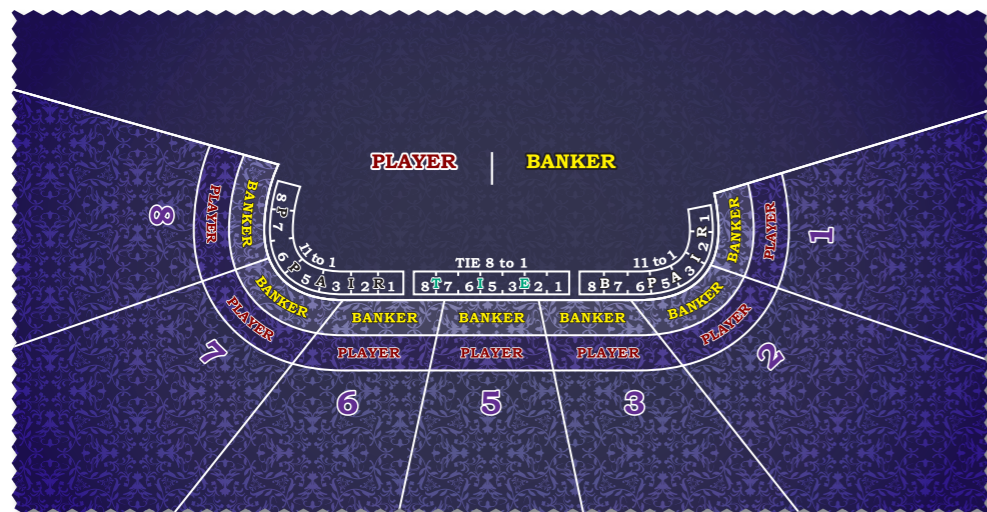

Graphic printing available for synthetic layout. Please contact your Matsui sales for more details.

# BACCARAT (size: mm)

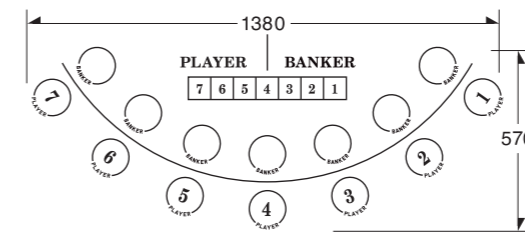

**WL.0606** 2300 x 1200

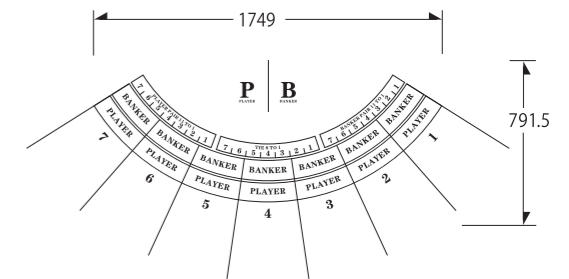

**WL.0648** 2600 x 1600

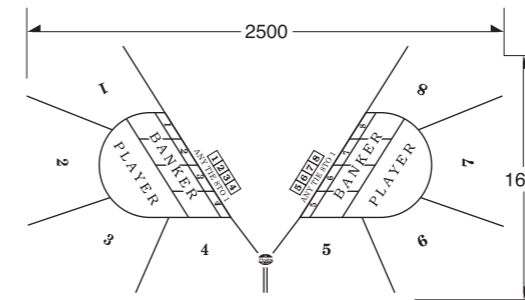

**WL.080** 2600 x 1600

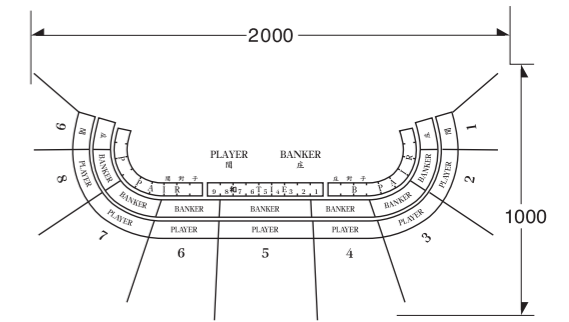

**WL.0630 B** 2600 x 1600

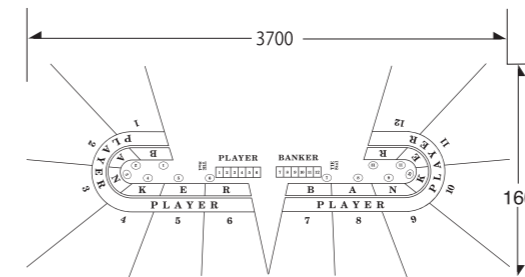

**WL.1202** 3700 x 1600

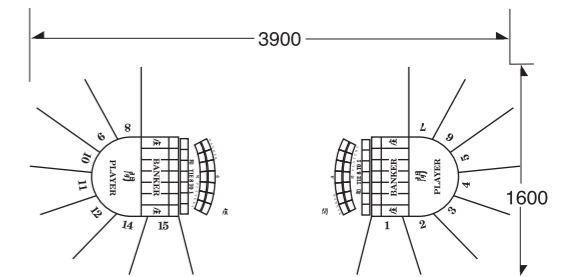

**WL.1404 C** 4000 x 1600

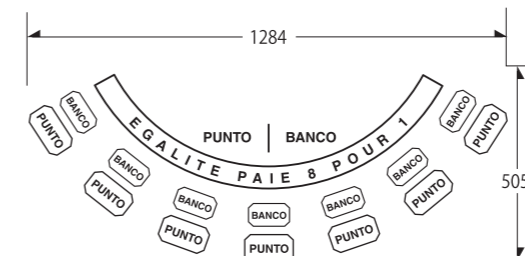

**ML00789-16K** 2300 x 1600

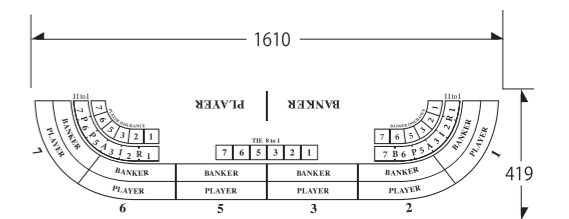

**ML00316-14K** 2300 x 1600

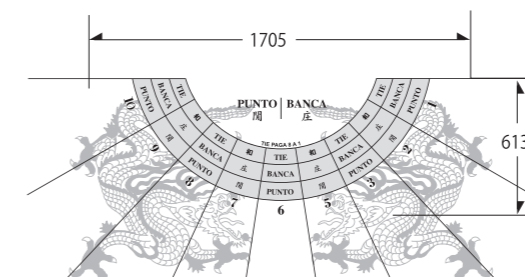

**ML00644-13K** 2300 x 1500

### BLACK JACK (size: mm)

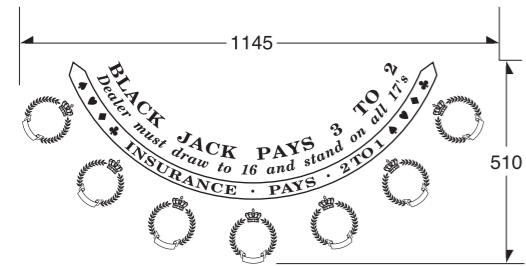

WL.010 2300 x 1200

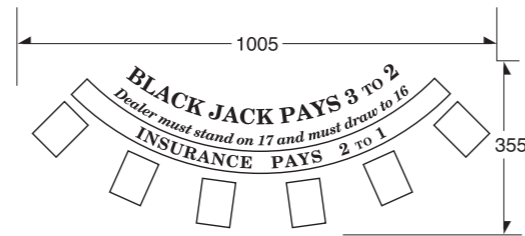

WL.011 2300 x 1200

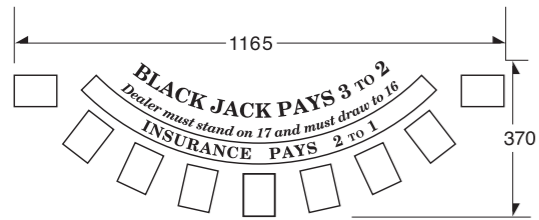

WL.013 2300 x 1200

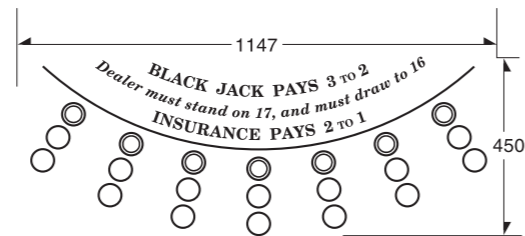

WL.014 2300 x 1200

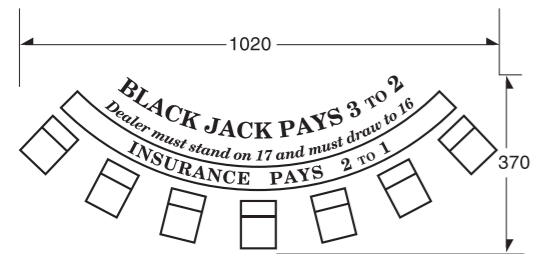

WL.0111 2300 x 1200

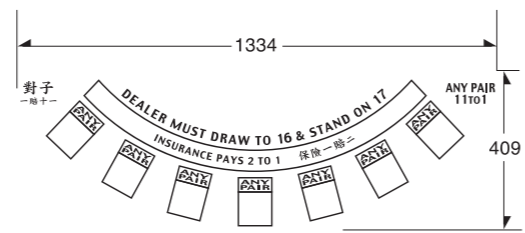

ML.00023-10J 2300 x 1200



Graphic printing available for synthetic layout. Please contact your Matsui sales for more details.

### POKER (size: mm)

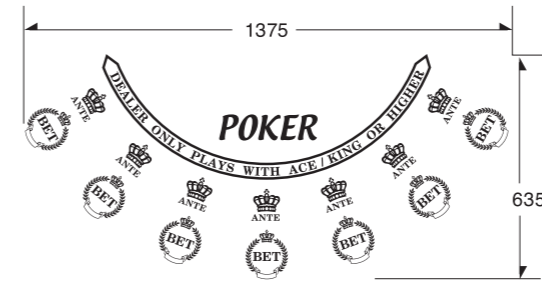

WL.0403 2300 x 1600

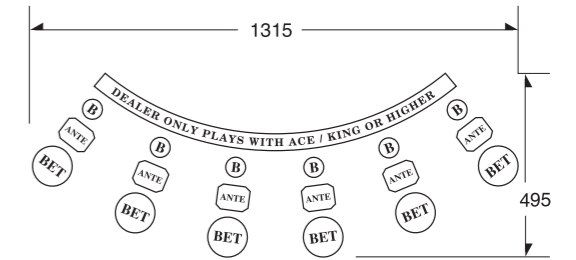

WL.2001 2300 x 1200

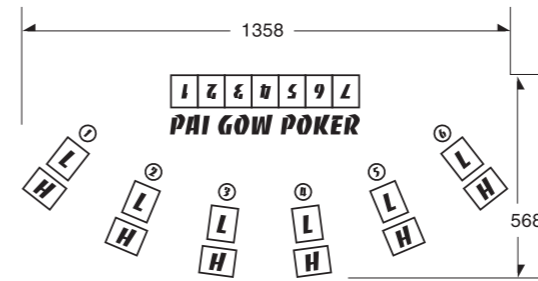

WL.0619 2300 x 1600

### TEXAS HOLD'EM (size: mm)

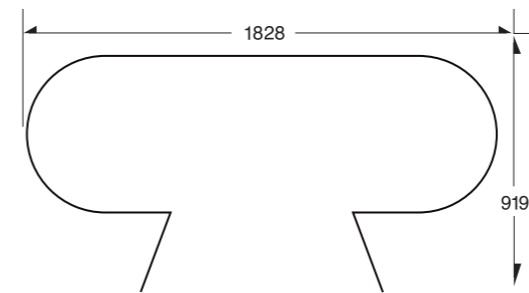

WL.2004 2600 x 1200

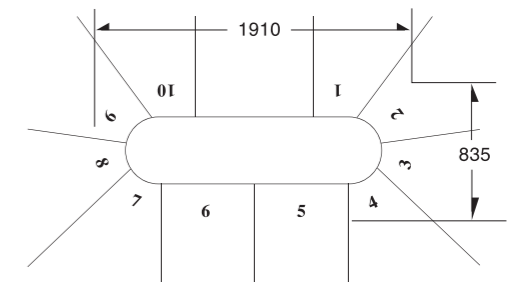

WL.2018 2700 x 1600

### CRAPS (size: mm)

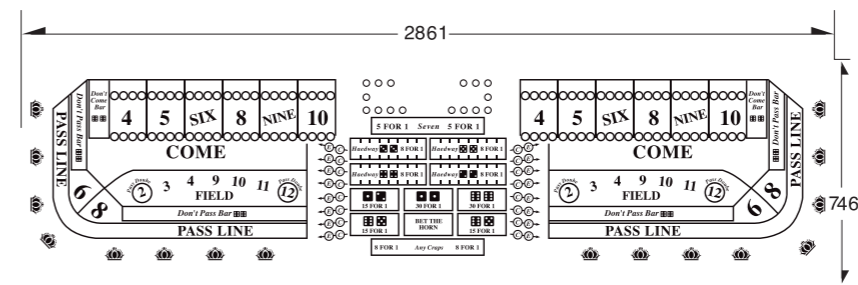

WL.2020 3600 x 1600

# NOVA GUARD Layout

NOVA GUARD LAYOUT by MATSUI ensures any part of the table layout cloth that comes into human contact in the casino is antimicrobial, therefore stopping the growth or spread of microorganisms.

- \* Identical feel, weight and quality finish with Matsui Heavy Weight Synthetic Layout
- \* With antimicrobial material added in the textile at the production stage whilst still allowing game / graphic design uniquely tailored to your casino
- \* Unlike the similar products which have only the surface of the cloth sprayed or coated by anti-viral solution; NOVA GUARD LAYOUT contains antimicrobial material woven into the fibre.
- \* Protection for not only a short period of time but instead constantly during the full period of use for your layout
- \* Offer a sanitized and safe environment at your gaming tables

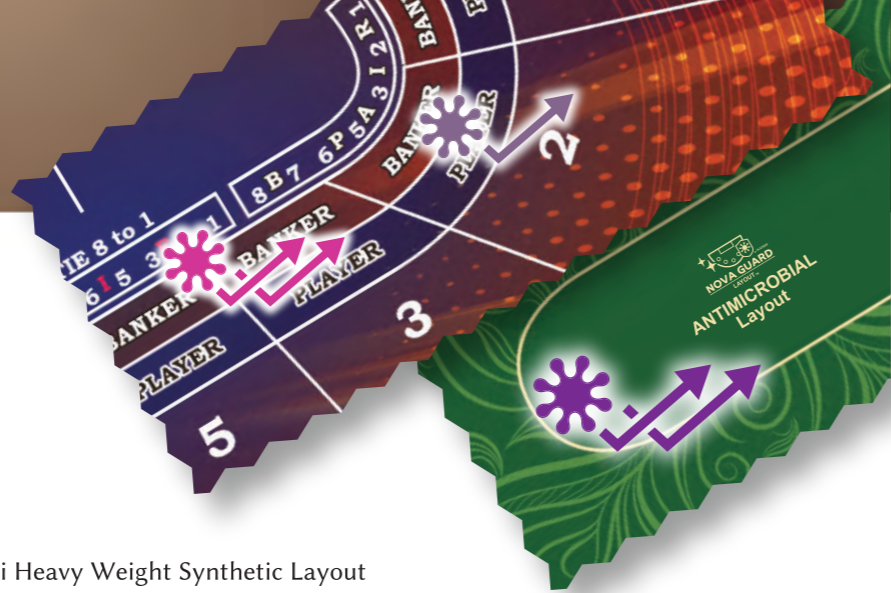

# Antimicrobial Casino Chip NOVA GUARD CHIP PROTECT

Available with all MATSUI Chips across the range with or without a decal and including Premier Decal Chips. NOVA GUARD CHIPS have a silver based antimicrobial agents added at the production stage that is effective against a broad spectrum of microbes. Registered at SIAA (Society of International sustaining growth for Antimicrobial Articles, Japan), the antimicrobial agent is extremely safe and USFDA approved for use. NOVA GUARD CHIPS have been laboratory tested for their effectiveness at disabling a variety of Bacteria and Viruses

- \* The same weight, feel and colours as standard Matsui Chips
- \* Effectively enhances the antimicrobial power of silver against a variety of microbes
- \* The same antimicrobial agents are widely and successfully applied to everyday household items, sports equipment, toys and textile products.
- \* Reduces the amount of cleaning required compared to standard gaming chips.
- \* Does not required to be cleaned by potentially damaging cleaning products like sterilizing with antiviral sprays or Ultraviolet Sterilizers.
- \* Additional reassurance for Casino staff and Customers that Bacteria and Viruses cannot live on the Chip or Decal surfaces.



# THE REVOLUTION Wheel

Elegant in design and finished with the world's finest veneers. Designed and manufactured in Japan, the MATSUI RevolutionWheel is a pre-requisite for any casino. Proven in tests, the new bearing assembly guarantees a spin rate, which is unsurpassed in its smoothness and duration. Equipped with a non-ferrous separator ring which can be indexed to 37 or 38 positions, the MATSUI Revolution Wheel is fully tamper proof for guaranteed security.

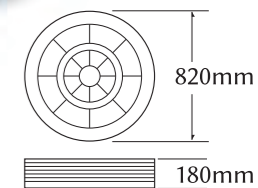

**The colours and design  
can be customized  
to suit your operation.**

- ① Turret machined and polished from solid metal and can be engraved with the casino name and logo.
- ② Adjustment bolt
- ③ Japanese designed and precision-engineered bearing assembly ensures a superior spin rate.
- ④ Cone finished with the finest veneers.
- ⑤ Non-ferrous CNC machined separator ring, capable of being indexed to 37/38 positions.
- ⑥ Rotor assembly machined to 0.1mm tolerances.
- ⑦ Ball track made from versatile heat resistant Bakelite, preventing wheel bias from premature wearing.



The Revolution is available with single or double zero. Font and colours can be customized.

# CARD SHREDDER

Will shred all known paper/plastic playing cards.  
Bent cards are not a problem!



## MA-5 for PLASTIC & PAPER playing cards

Designed for back room use, the powerful MA-5 can shred over 20 decks per minute and the MA-6 can easily shred over 30 decks per minute ensuring all used cards are thoroughly disposed of while saving valuable hours in the process.



## MA-6 for PAPER playing cards



### Specifications

Dimension	W195 x D185 x H655mm
Gross Weight • Material	13.7kg • ABS Resin and Steel
AC Main Lead	2800mm Length
Cutting Speed	20 Decks per minute
CUT	4(MA-5)/6(MA-6)pcs
Power Consumption	90W
Voltage	100-125V or 200-230V
Frequency	50/60Hz
Colour	Black
Accessories	Spring, AC cord, Allen Wrench x 2

# ACCESSORIES

Matsui Gaming can also provide a wide range of casino accessories. We are happy to support you in all your requirements. Please contact your nearest sales office for more details.



Roulette Ball



Roulette Win Marker



Baccarat Marker



Lammer



Matsui Premium Playing Cards  
Matsui Standard Playing Cards



Craps Dice



LCD Table Limit Sign



Solid Dealing Shoes

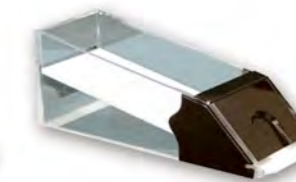

Clear with Colored Trim  
Dealing Shoes-1

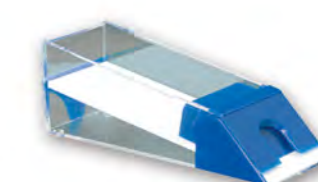

Clear with Colored Trim  
Dealing Shoes-2



Digital Limit Signs



DS080 Dealing Shoe  
(For 8 Deck, Frosted)



DS050 Dealing Shoe  
(For 8 Deck, White)



DS030 Dealing Shoe  
(For 8 Deck, Black)

# CASINO THEMED Ashtrays

Our casino themed ashtrays are a perfect customer/prize give away, these porcelain hand painted ashtrays can also be customised and painted in your preferred colour with casino logo providing constant advertising for your casino.



**AT.020** Roulette Wheel -Big Size-  
φ200mm×H45mm / φ8inch×1.77inch



**AT.040** Roulette -Big Size-  
W240mm×D130mm×H40mm / W9.6inch×D5.11inch×H1.57inch



**AT.220** Roulette Wheel -Medium Size- (Black)

**AT.221** Roulette Wheel -Medium Size- (White)  
φ130mm×H30mm / φ5.2inch×1.18inch



**AT.120** Roulette Wheel -Mini Size-  
φ110mm×H25mm / φ4.4inch×H0.98inch



**AT.121** Roulette Wheel -X.Small Size-  
φ95mm×H20mm / φ3.8inch×H0.78inch



**AT.350** Gaming Chip  
φ81mm×H63mm / φ3.24inch×H2.48inch



**AT.030** Baccarat -Big Size-  
W240mm×D125mm×H33mm / W9.6inch×D4.92inch×H0.10inch



**AT.130** Baccarat -Mini Size-  
W140mm×D75mm×H25mm / W5.6inch×D2.95inch×H0.98inch

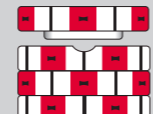
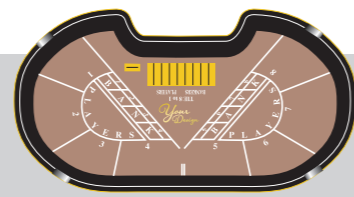
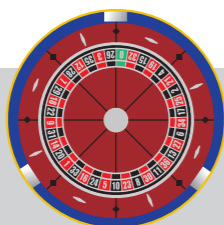

## CAN BE CUSTOMIZED

Colours and logos can be tailored to suit your needs.



**AT.010** Black Jack -Big Size-  
W240mm×D125mm×H30mm / W9.6inch×D4.92inch×H1.18inch



**AT.210** Black Jack -Medium Size- (Black)

**AT.211** Black Jack -Medium Size- (White)  
W165mm×D85mm×H28mm / W6.6inch×D3.34inch×H0.09inch



**AT.110** Black Jack -Mini Size-  
W140mm×D75mm×H25mm / W5.6inch×D2.95inch×H0.98inch



**AT.111** Black Jack -X.Small Size-  
W128mm×D65mm×H22mm / W5.12inch×D2.55inch×H0.86inch



**AT.310** Craps



**Ashtray**  
W162mm×D85mm×H35mm / W6.48inch×D3.34inch×H1.37inch

**Wooden Frame**  
W124mm×D60mm×H26mm / W6.48inch×D2.36inch×H1.02inch



**AT.320** Sic Bo  
W142mm×D90mm×H30mm / W5.68inch×D3.54inch×H1.18inch



**AT.340** Star  
W150mm×D120mm×H30mm / W6inch×D4.72inch×H1.18inch



**AT.330** Crown  
W123mm×D105mm×H30mm / W4.92inch×D4.13inch×H1.18inch

